



EVOTECH®
P E R F O R M A N C E

www.evotech-performance.com

Yamaha YZF-R7

Tail Tidy



Kit Contents PRN015775

- (A) 1 x Retro Light
- (B) 1 x Light Holder
- (C) 1 x Connector No.28
- (D) 2 x M4 Flange Nut
- (E) 2 x Cable Clip No.3
- (F) 2 x M4 x 6 Button Head Boltss
- (G) 2 x M5 x 12 Button Head Bolts
- (H) 4 x M5 x 16 Button Head Bolt

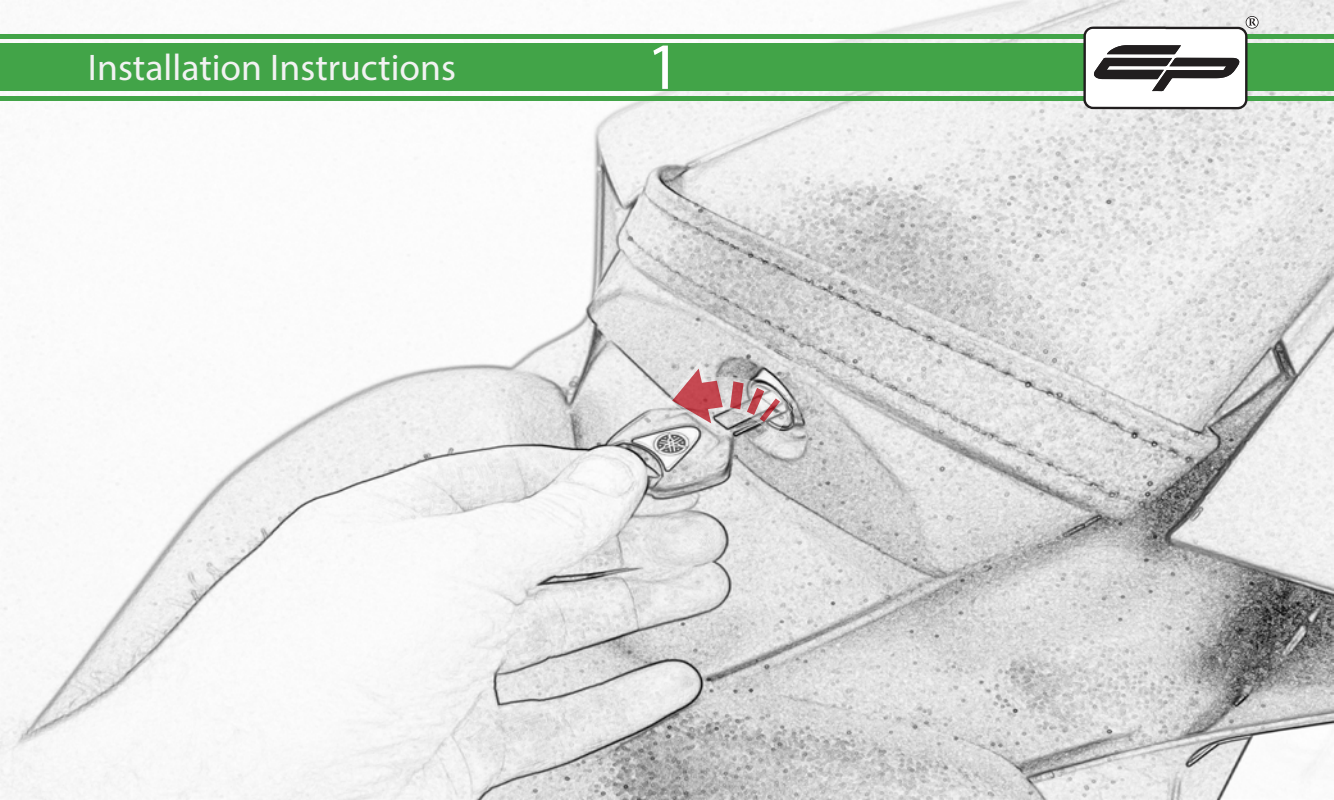

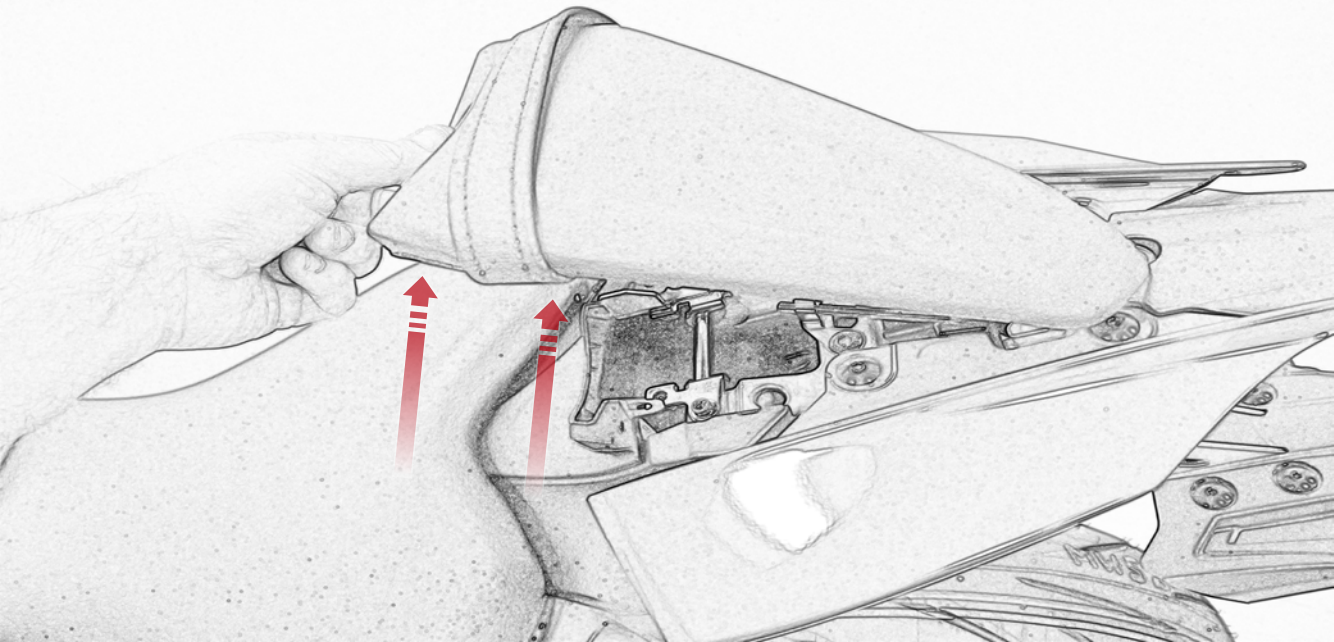



RELEASE

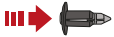

RE-SET



RE-FIT



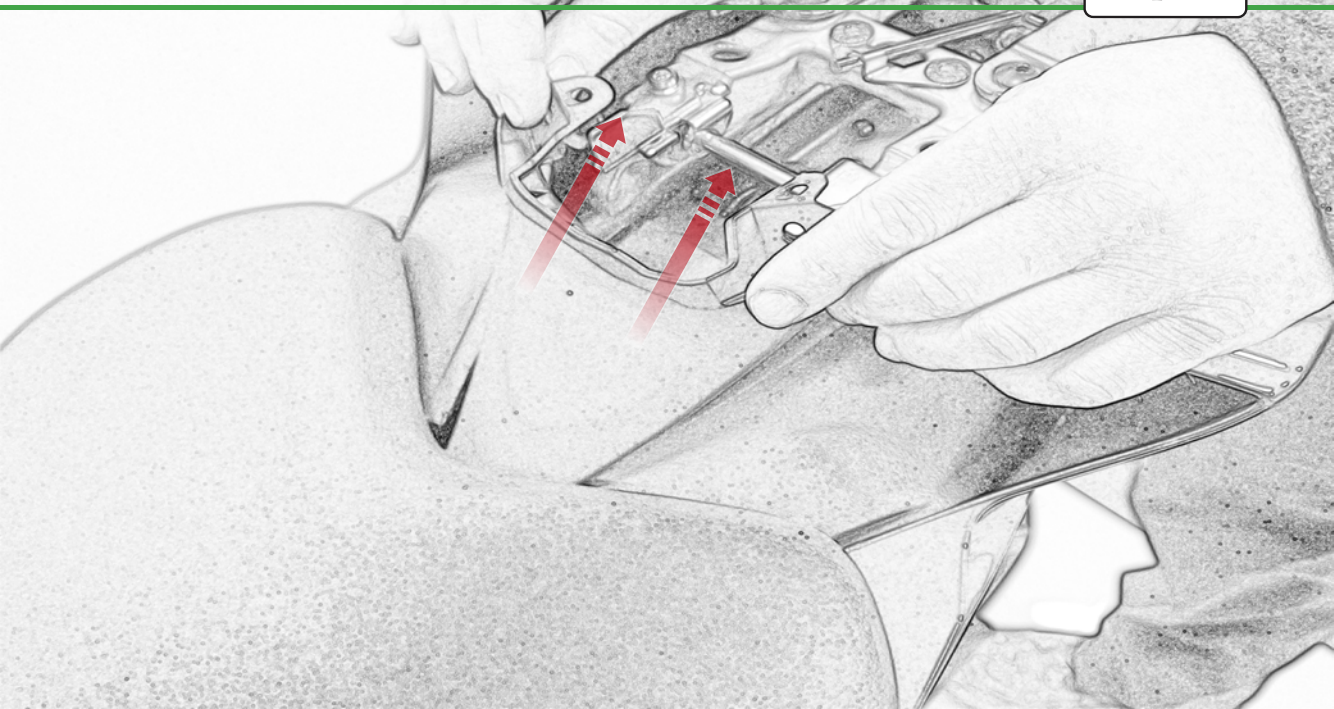

Installation Instructions

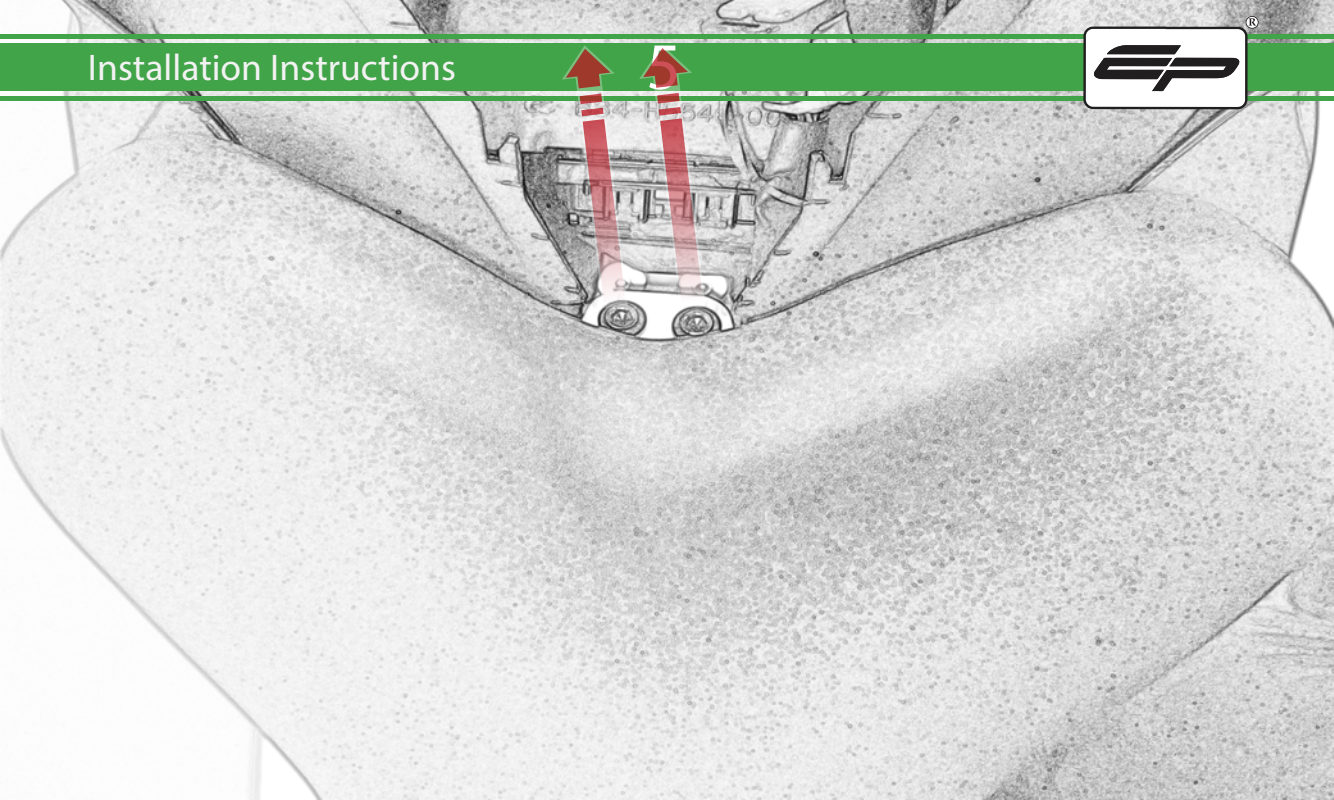

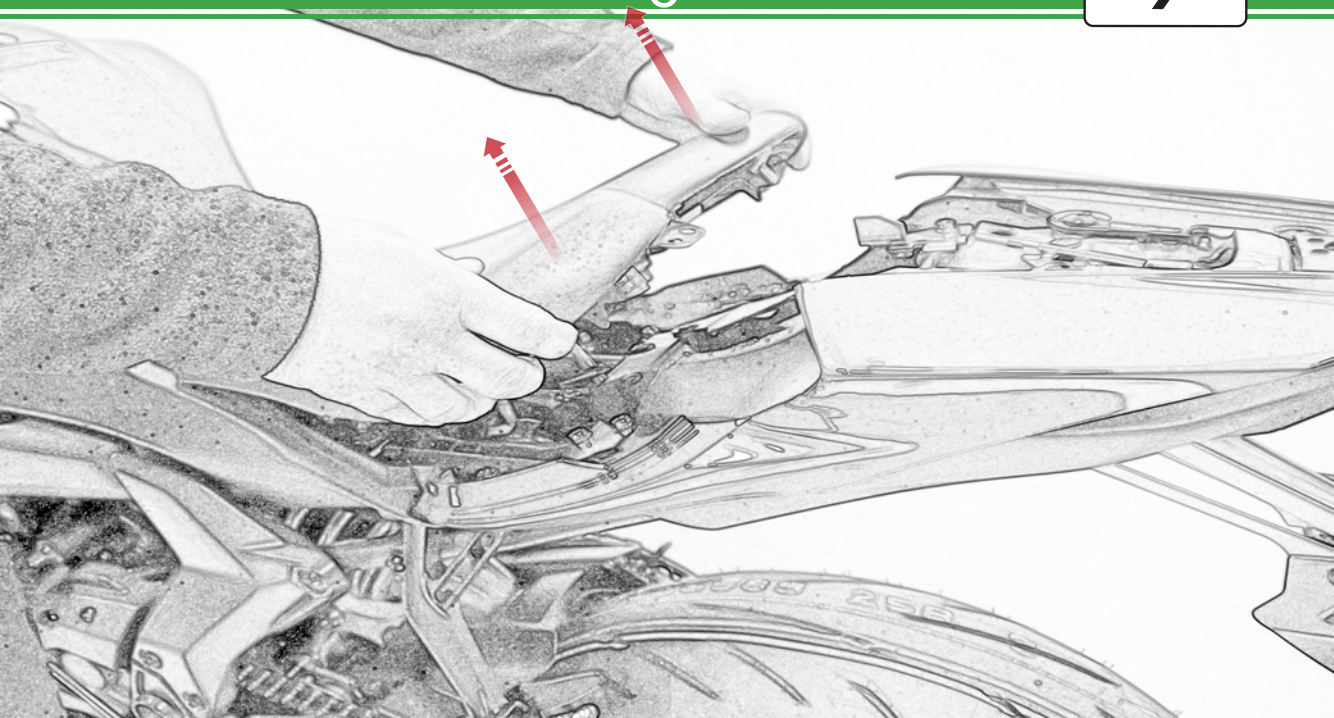

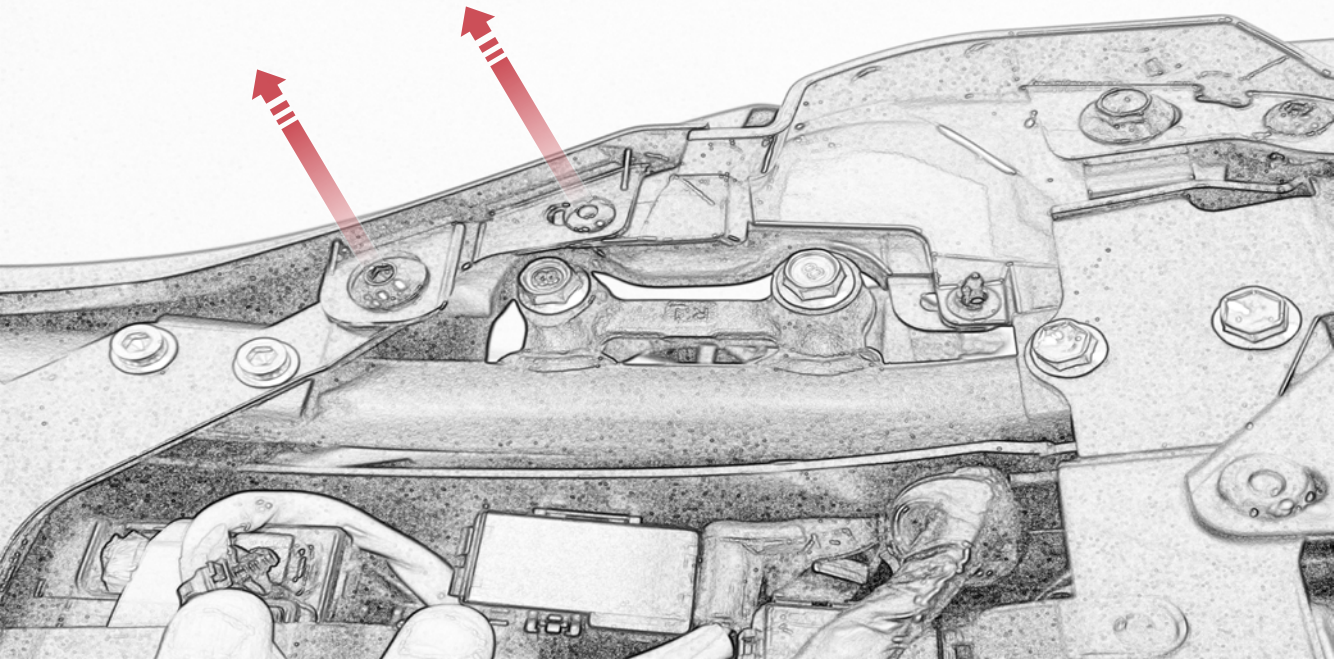

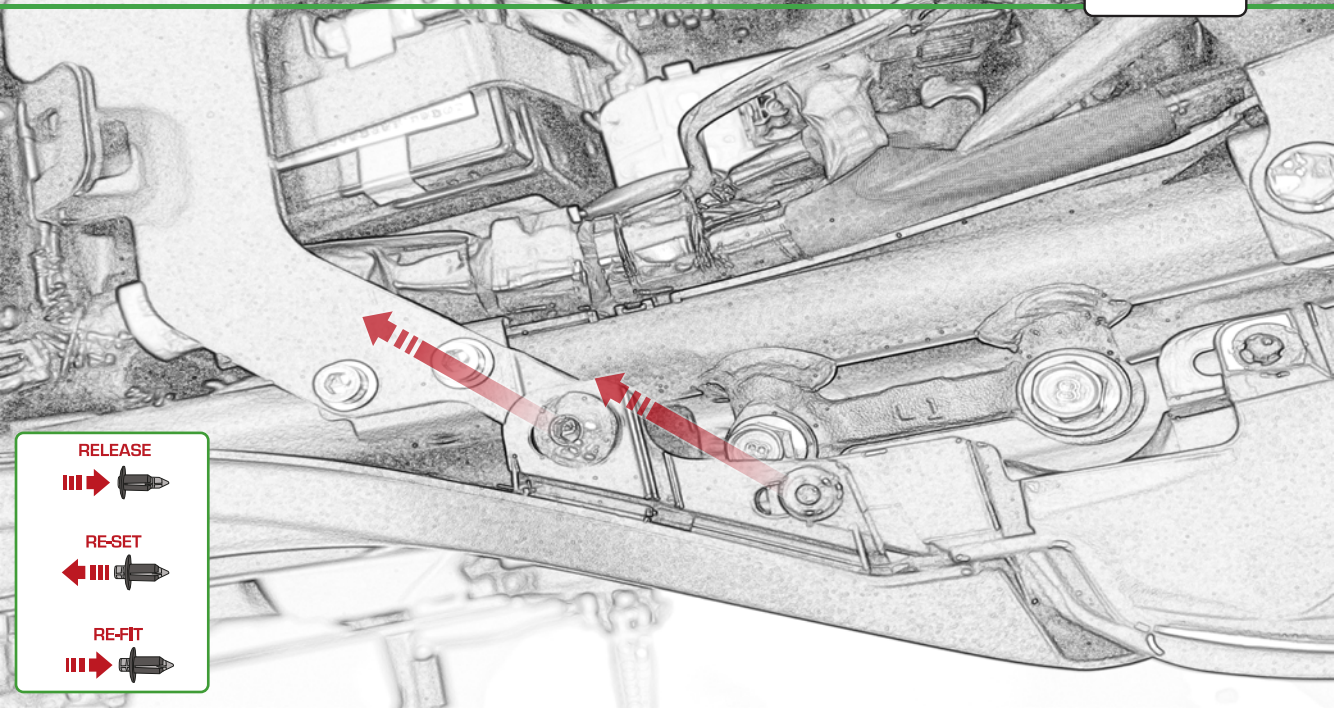

RELEASE



RE-SET



RE-FIT



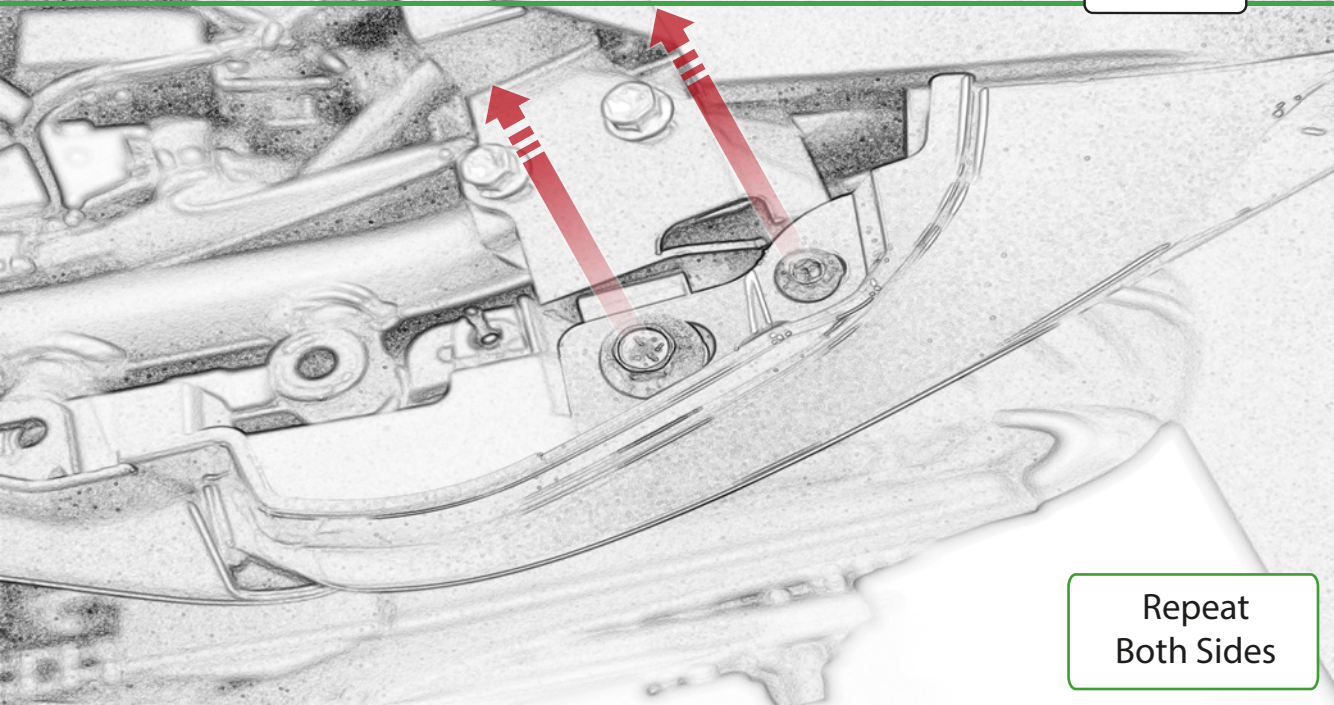

Repeat
Both Sides

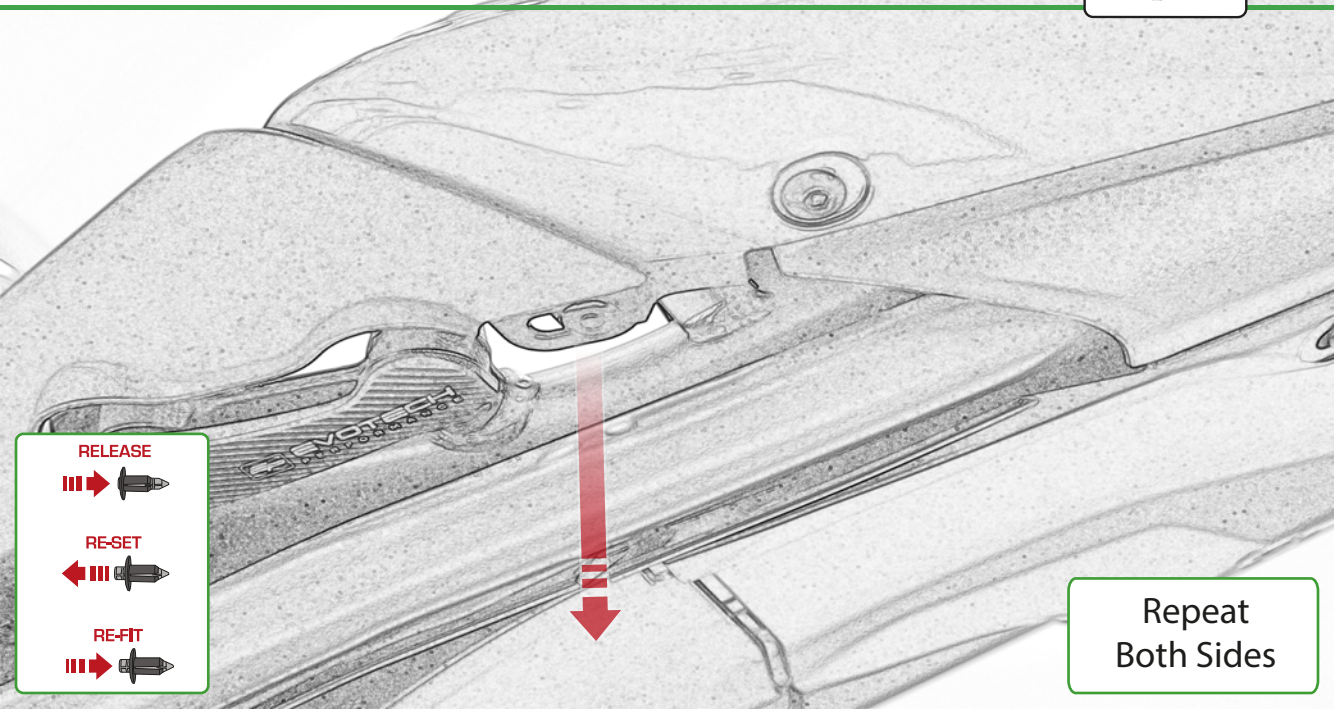

RELEASE



RE-SET



RE-FIT



Repeat
Both Sides



Repeat
Both Sides

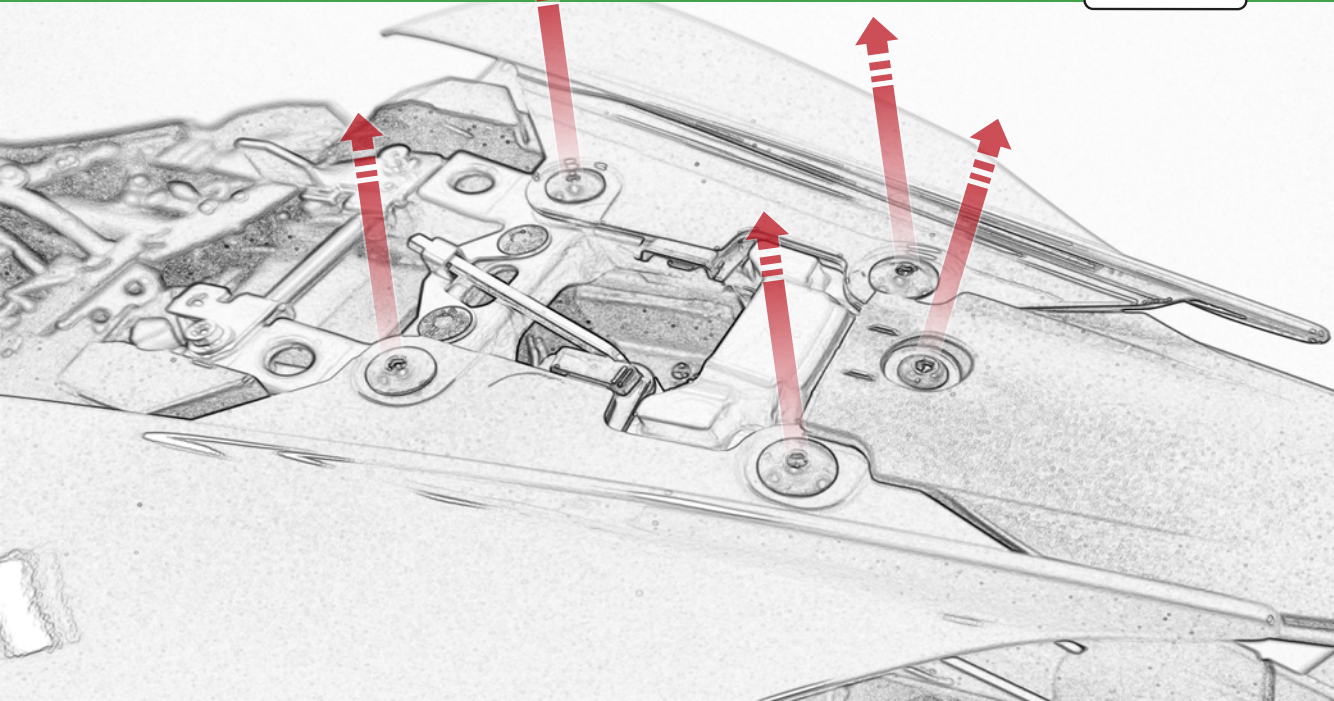

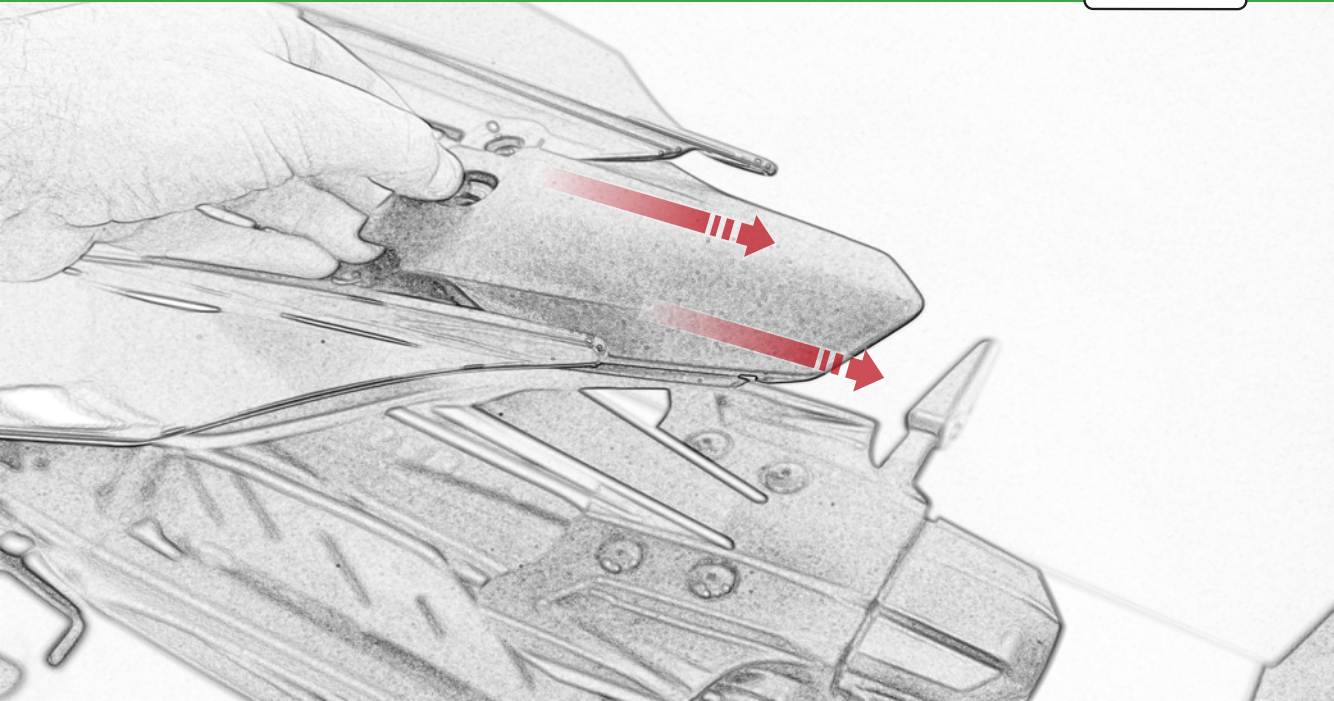

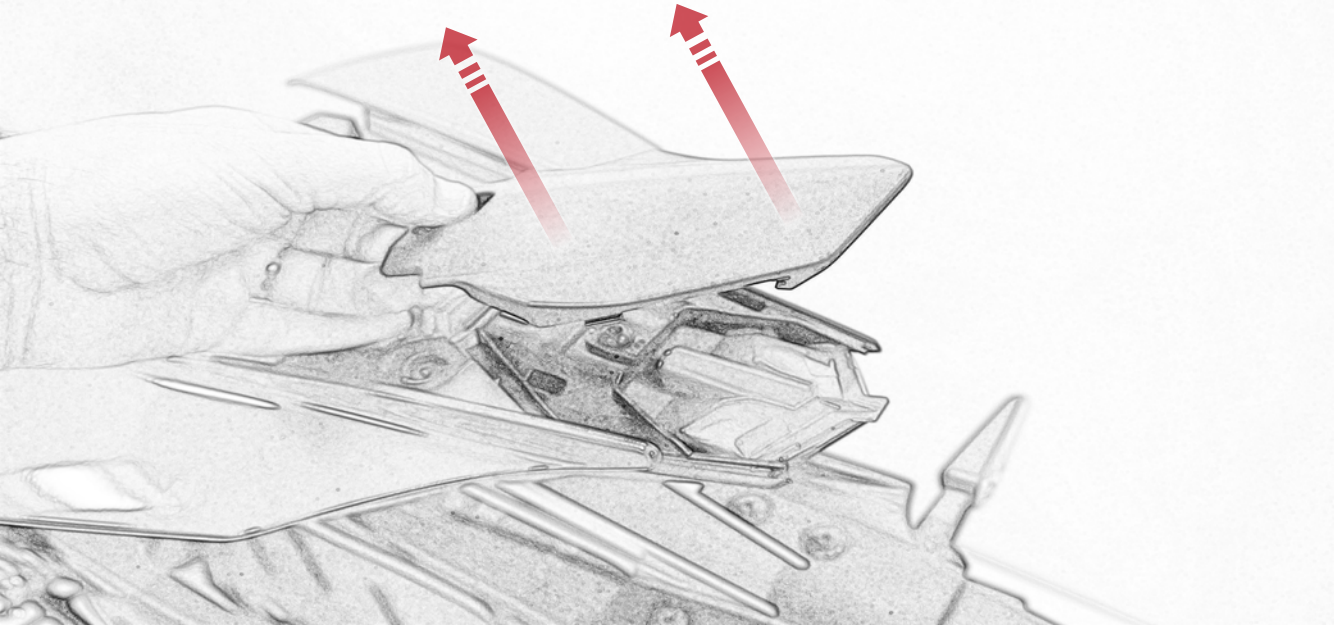

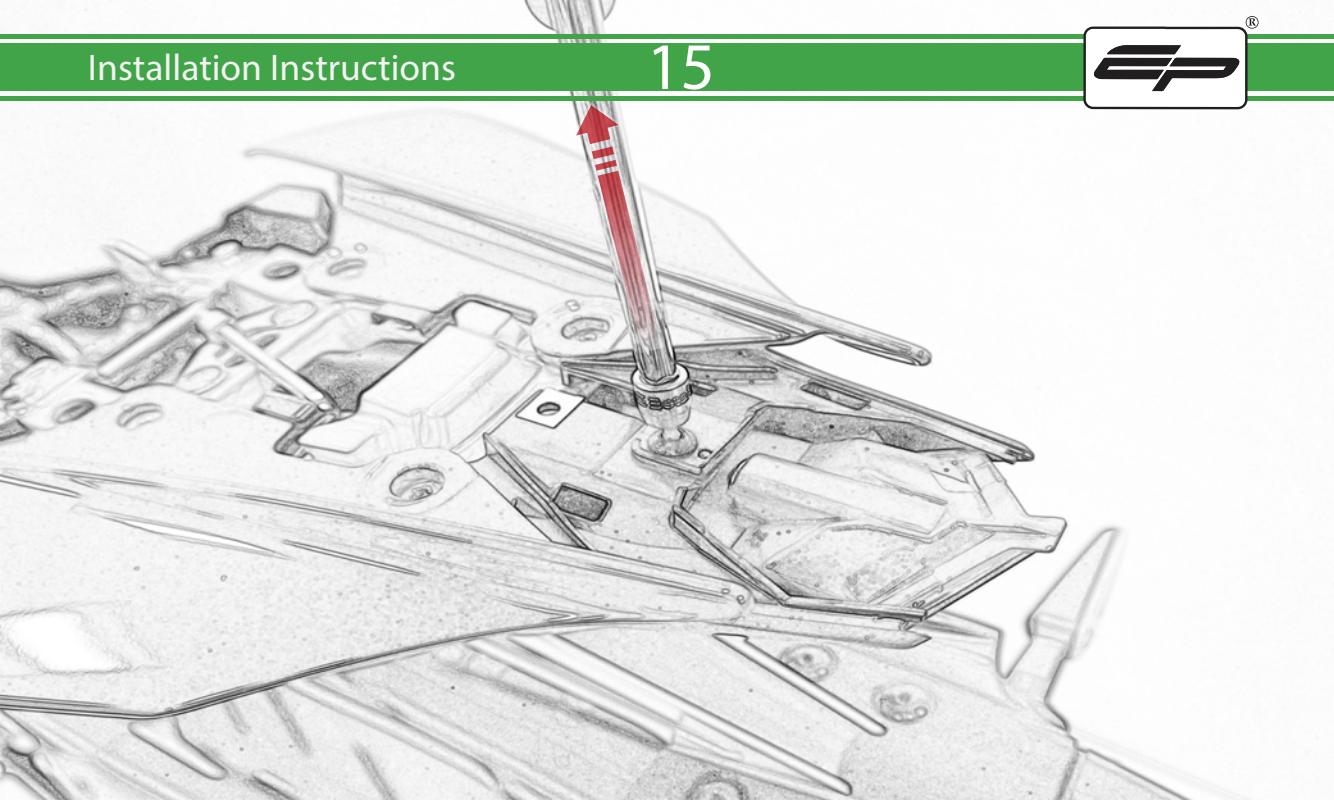

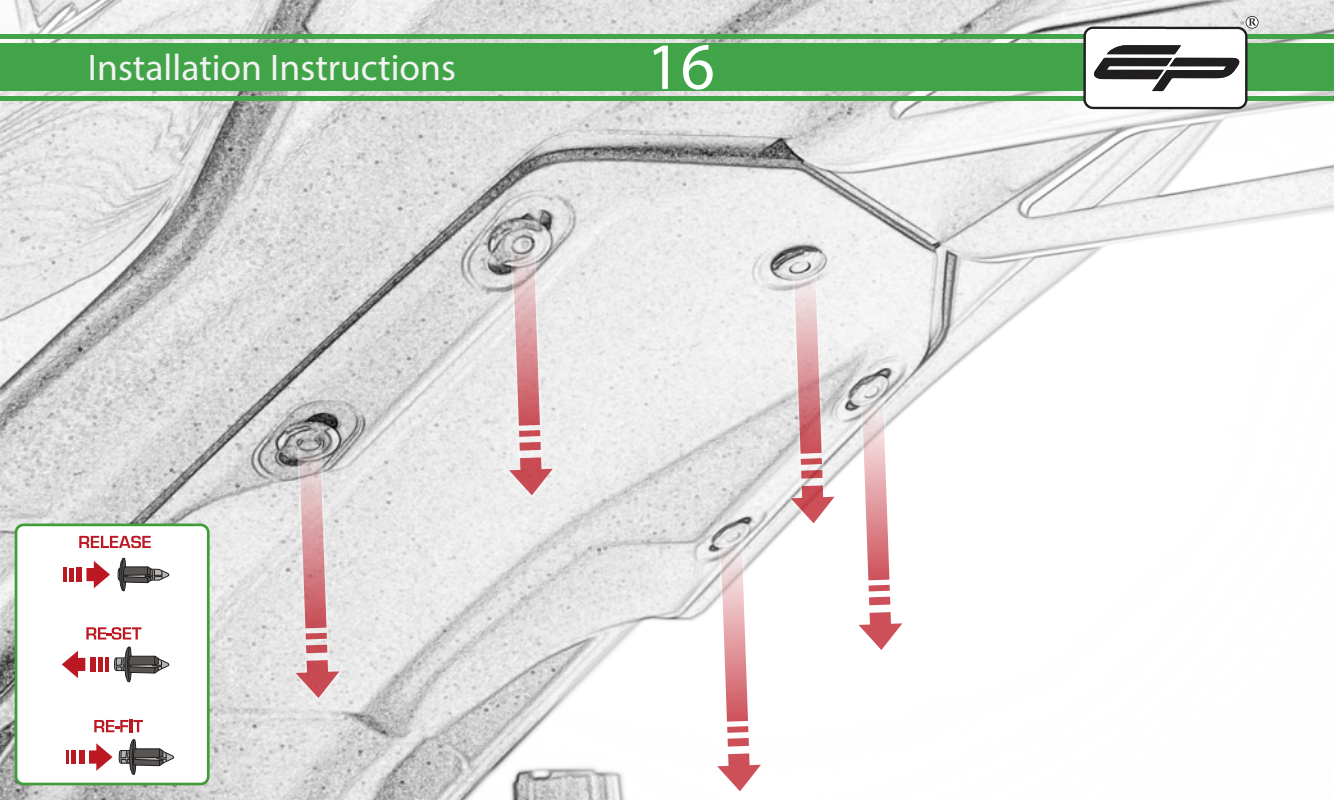

RELEASE



RE-SET



RE-FIT

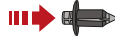

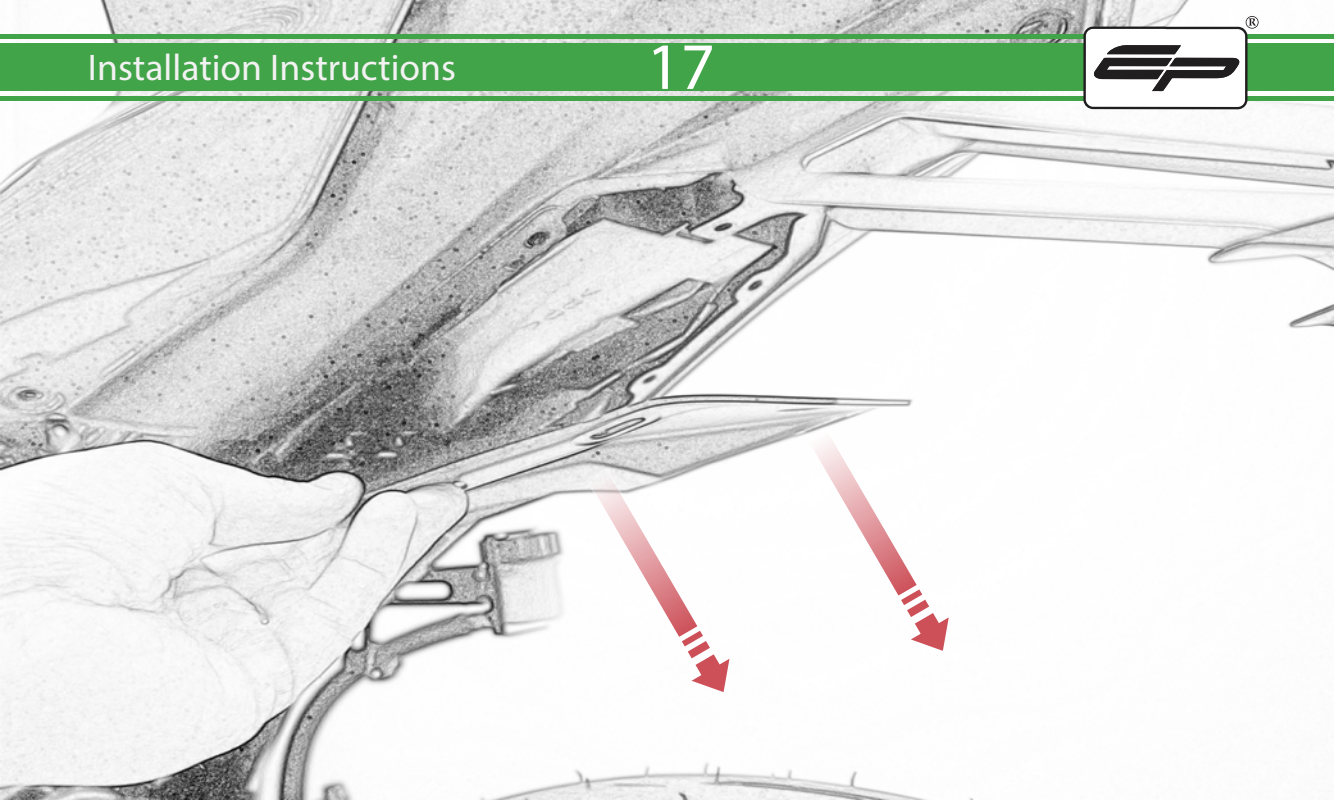



RELEASE



RE-SET



RE-FIT



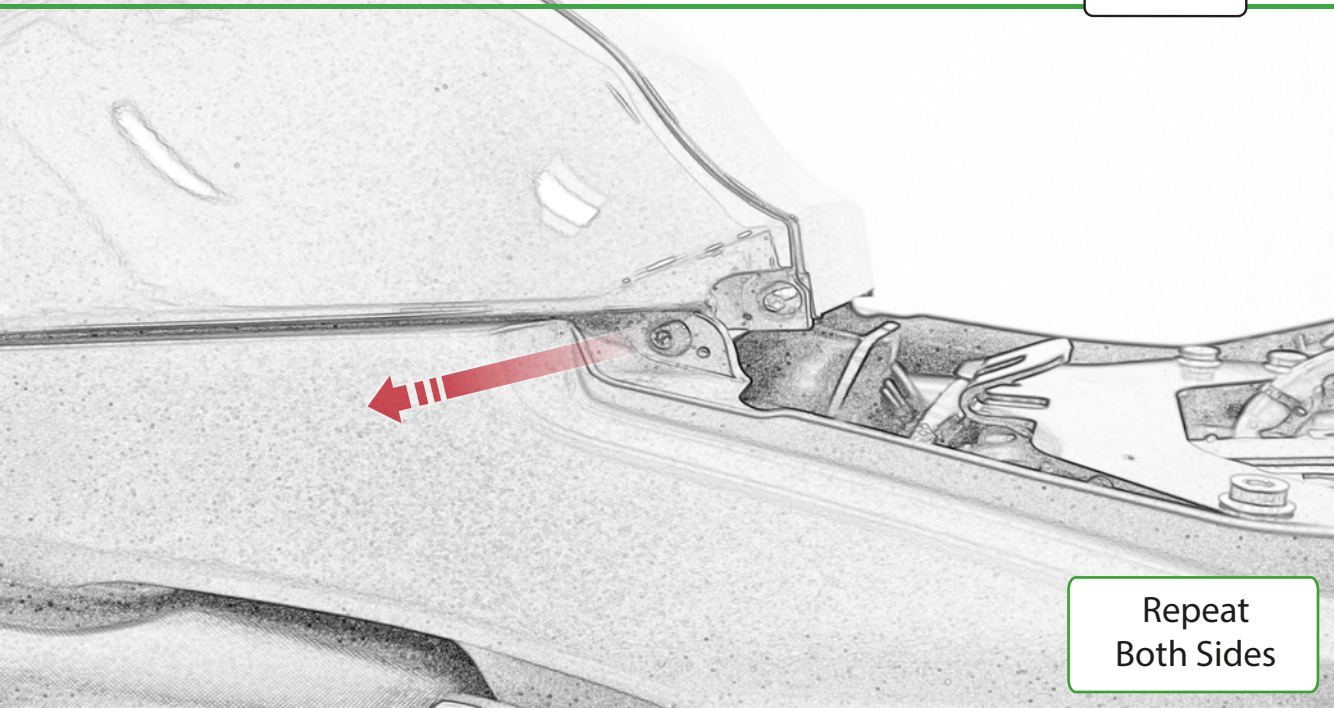

Repeat
Both Sides

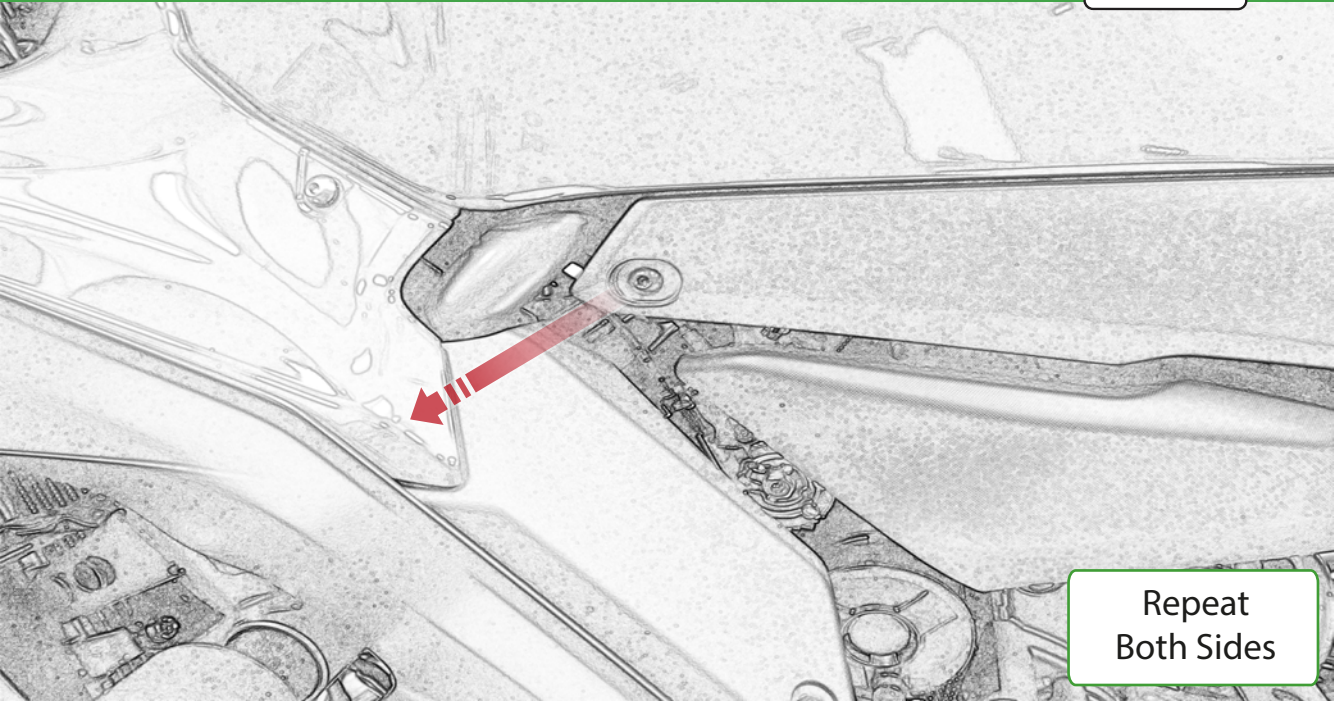

Repeat
Both Sides

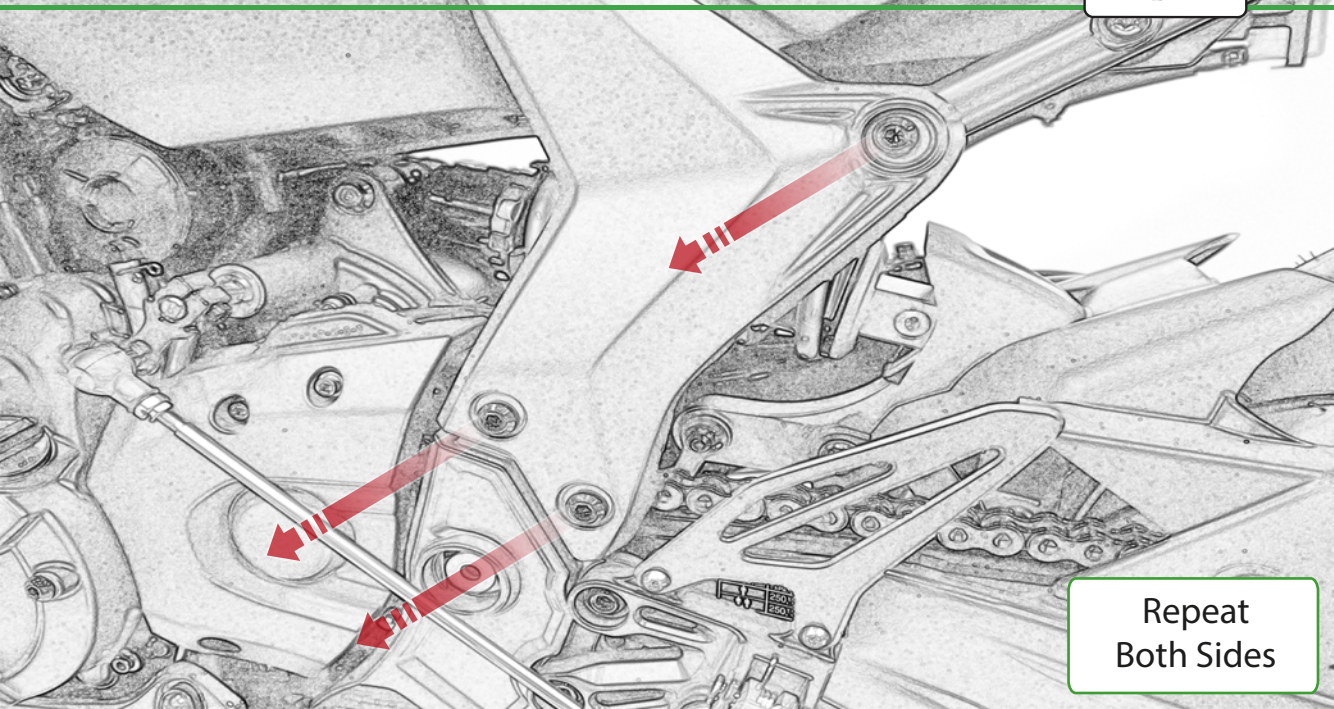

Repeat
Both Sides

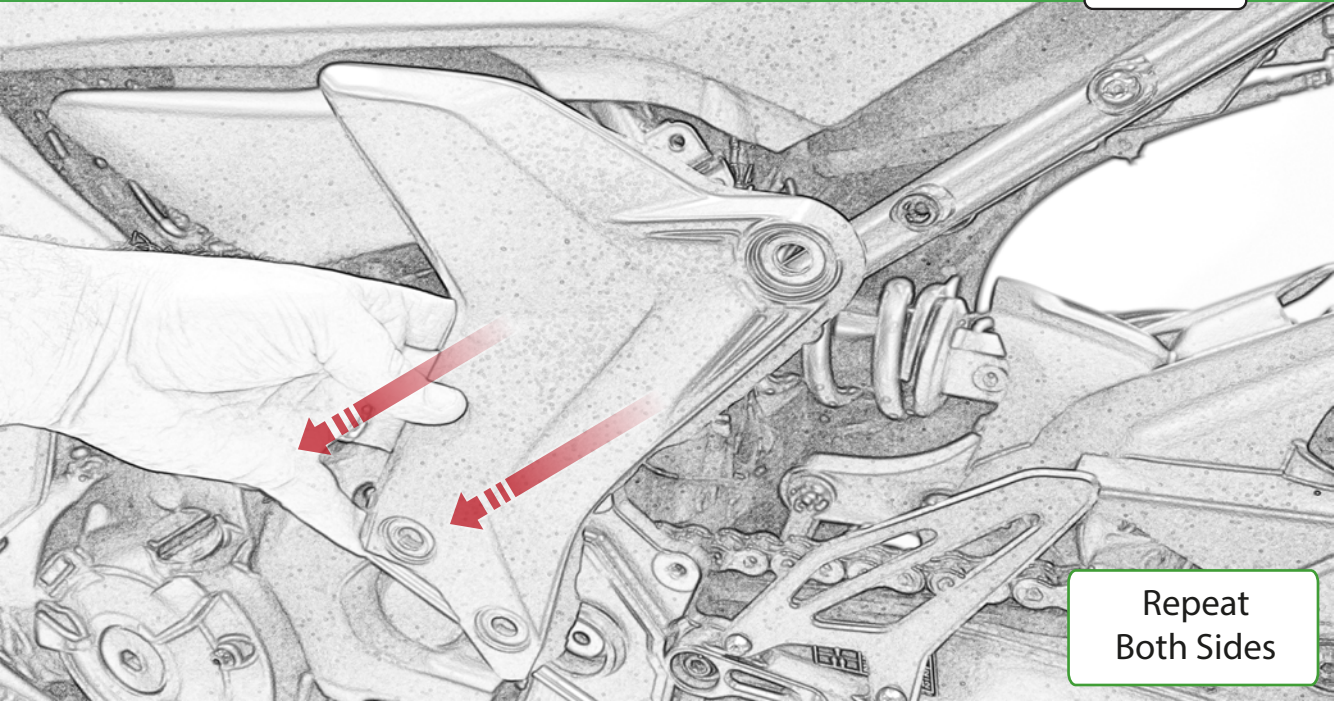

Repeat
Both Sides

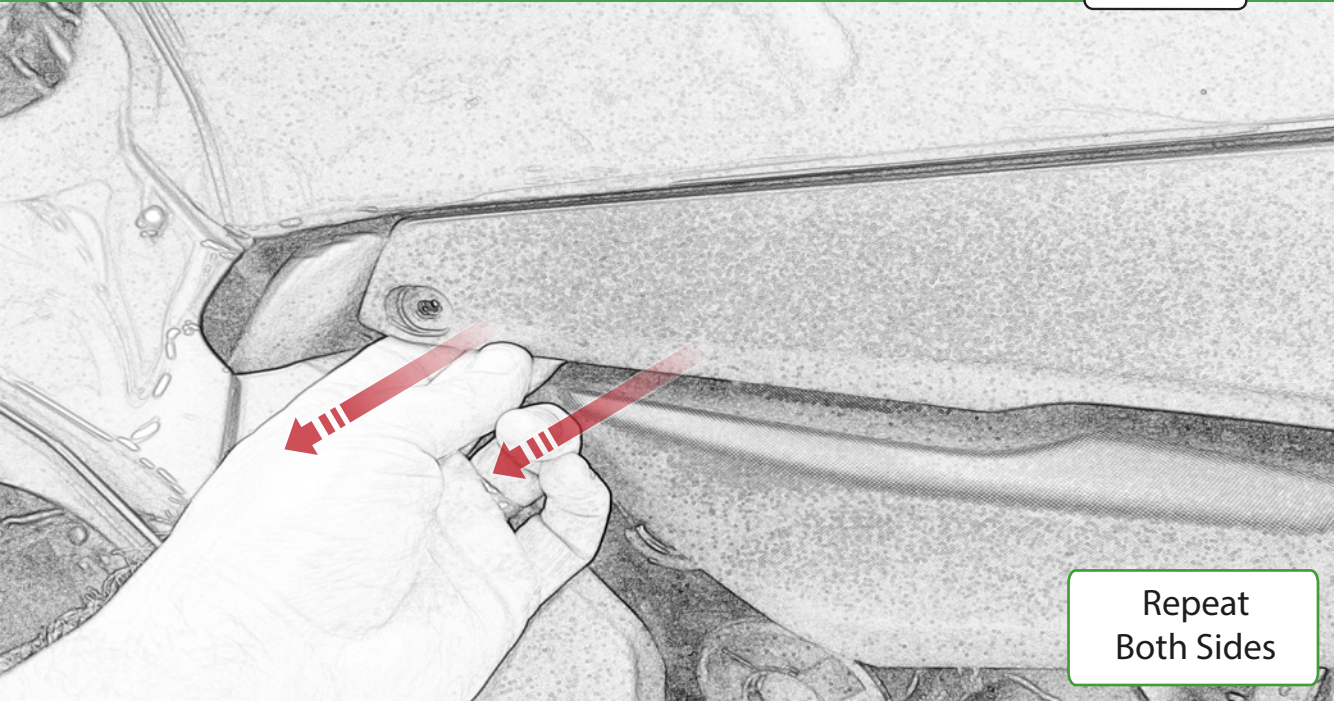

Repeat
Both Sides

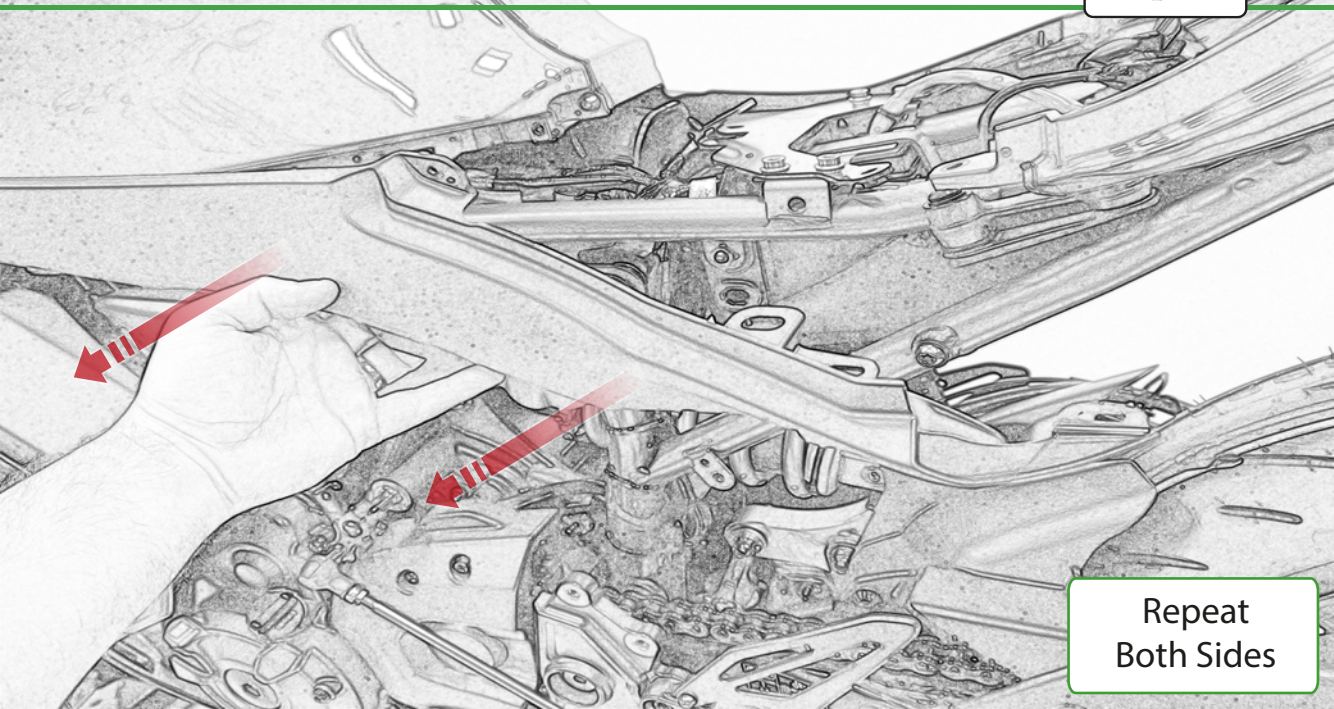

Repeat
Both Sides



RELEASE



RE-SET



RE-FIT



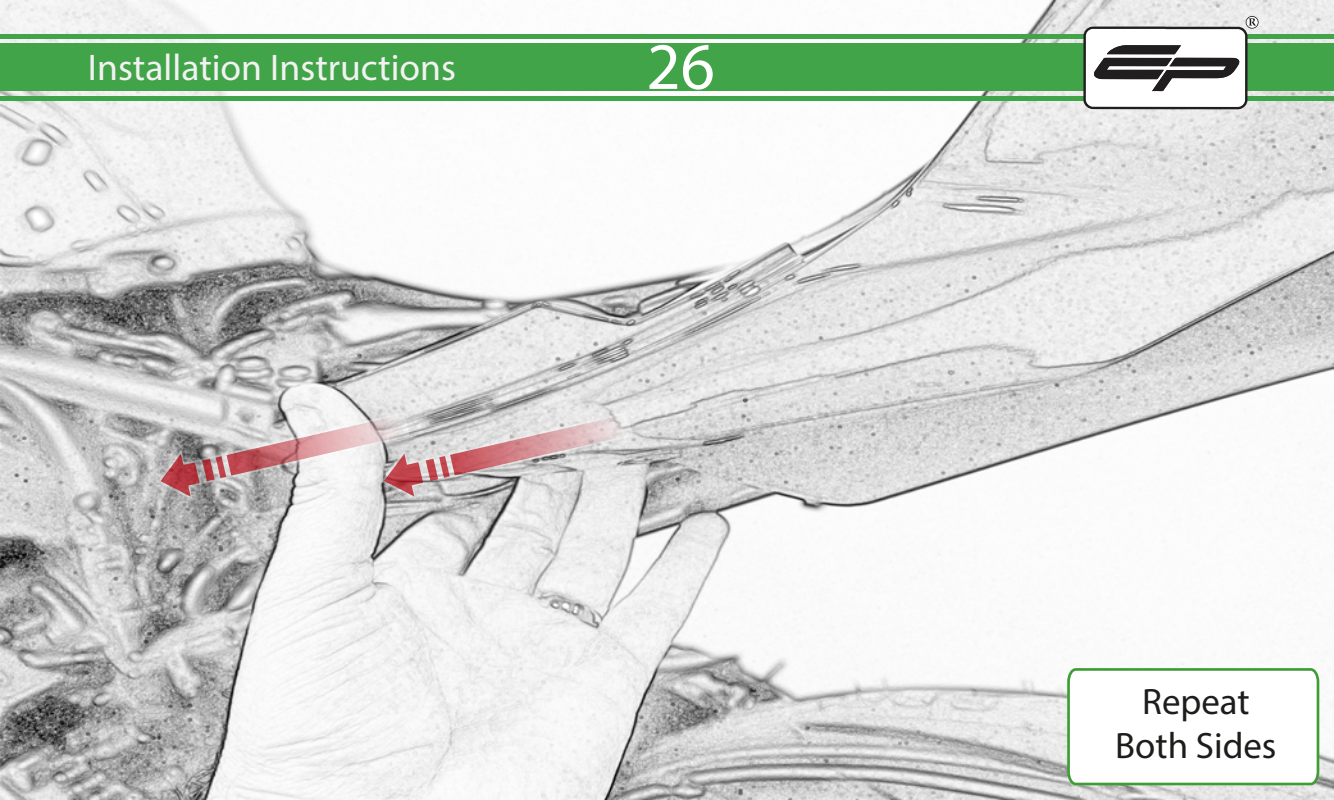

Repeat
Both Sides

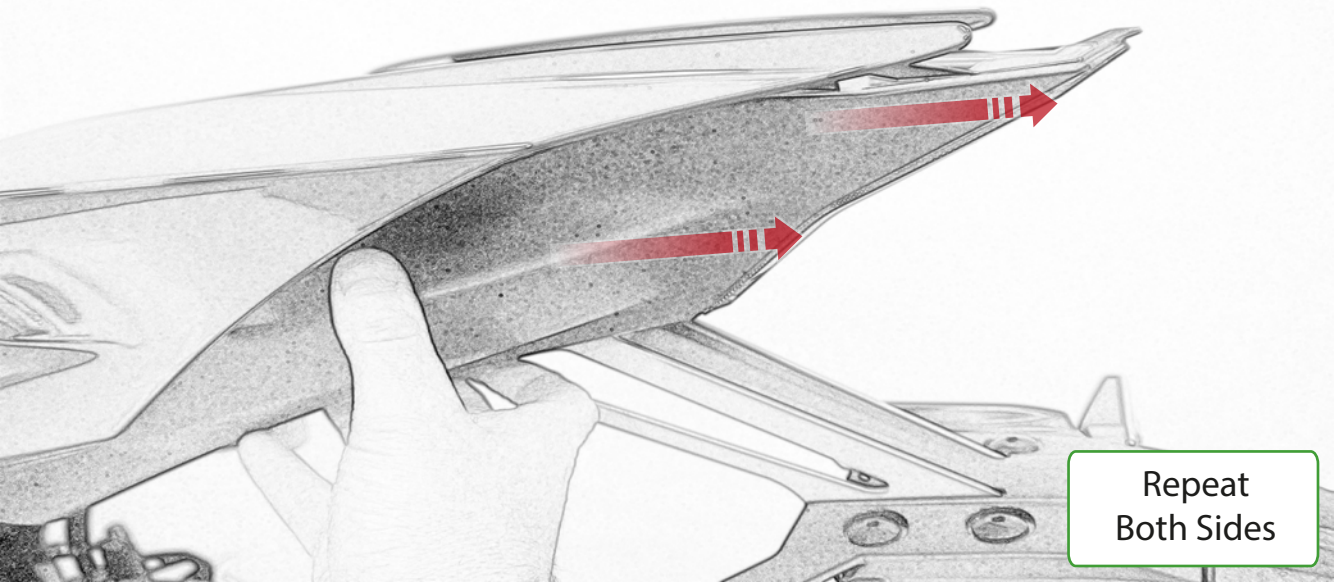

Repeat
Both Sides

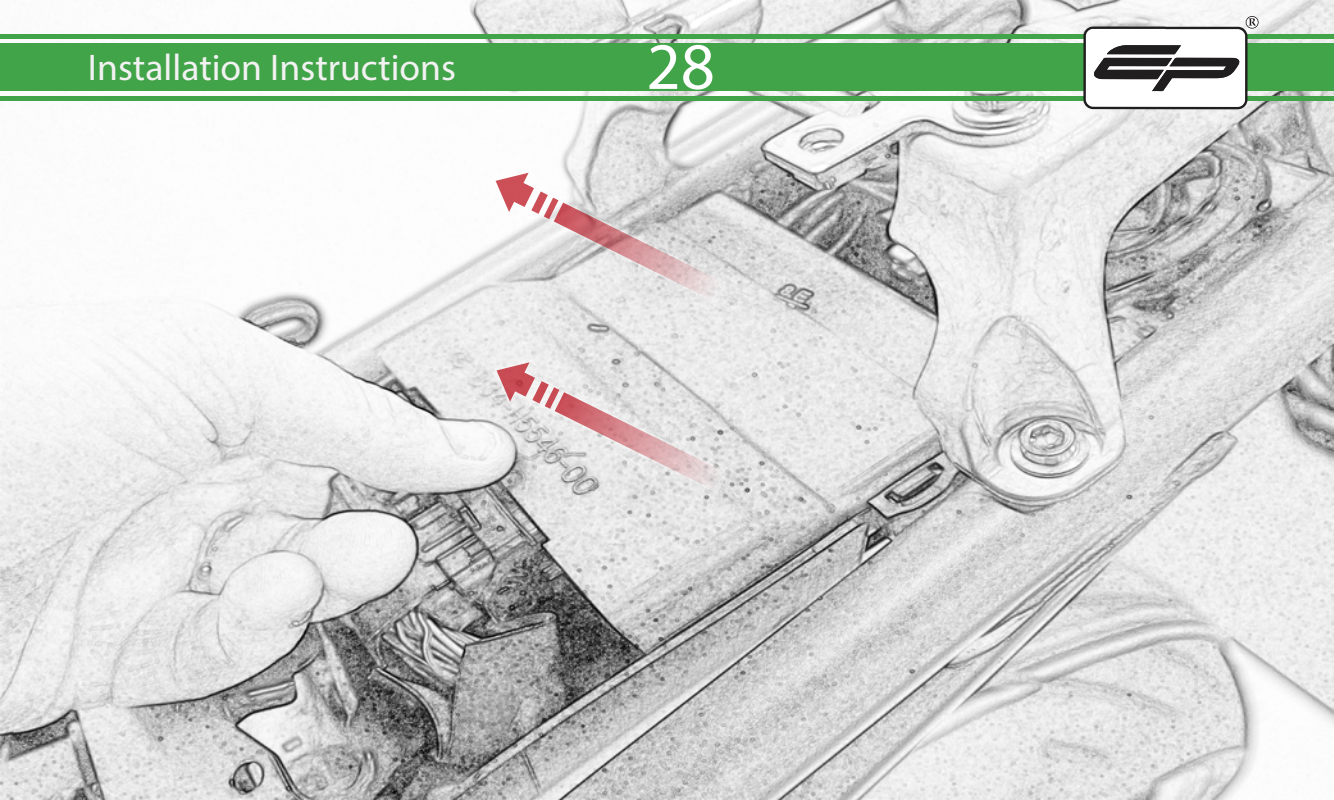

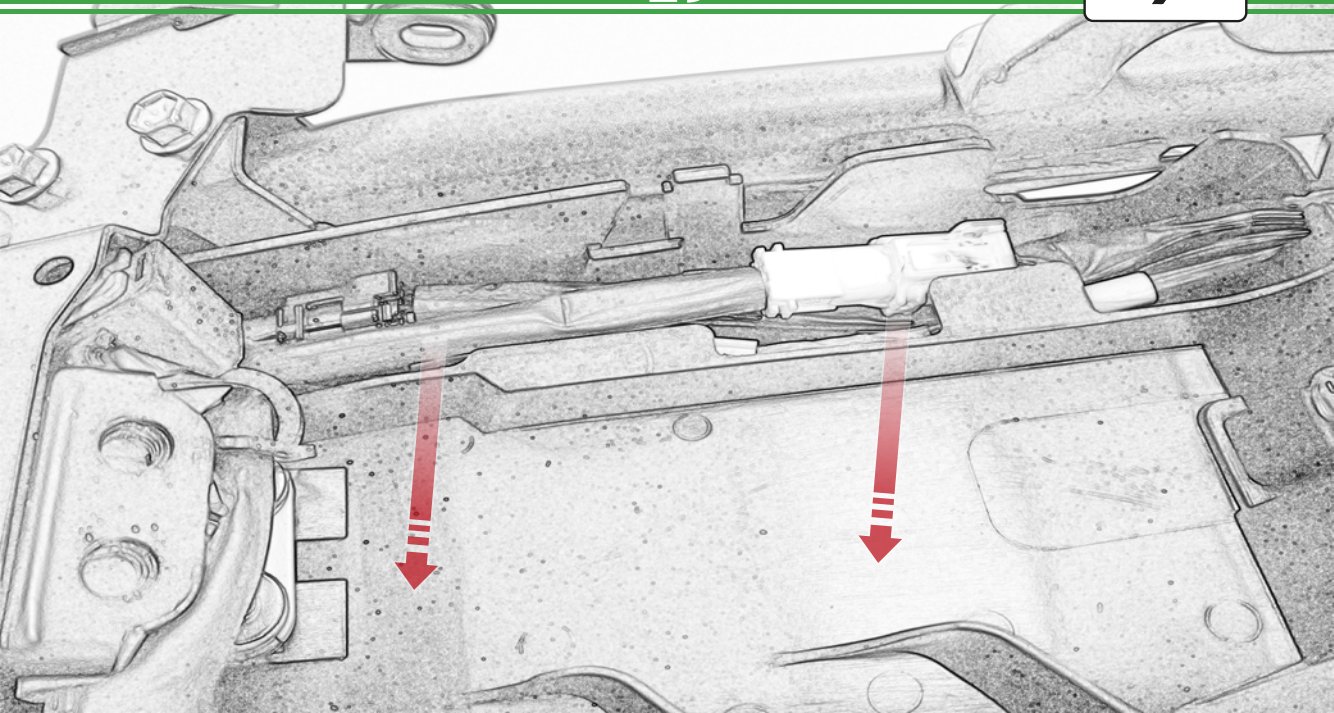

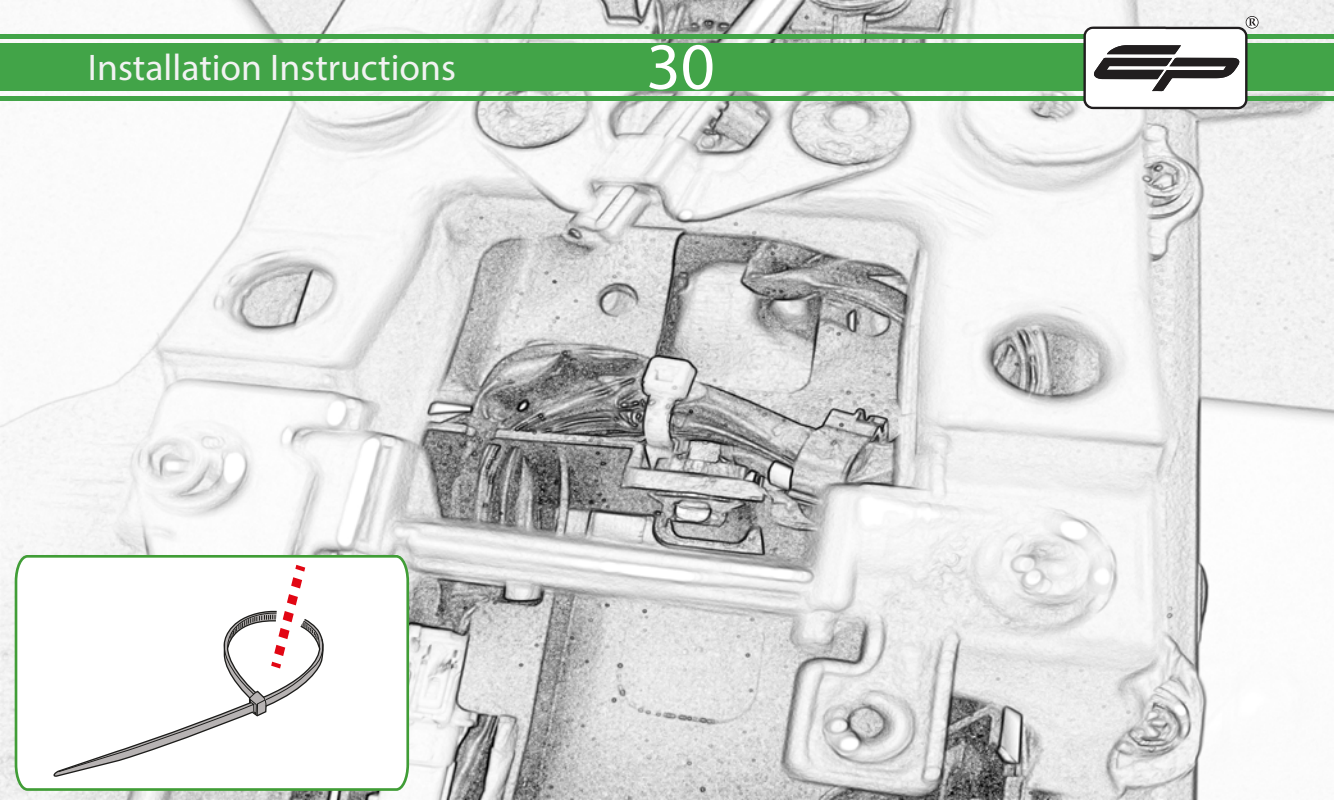
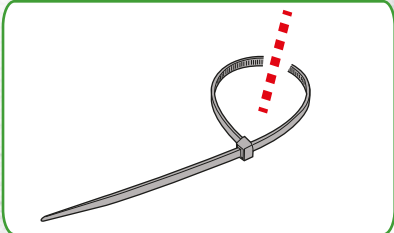

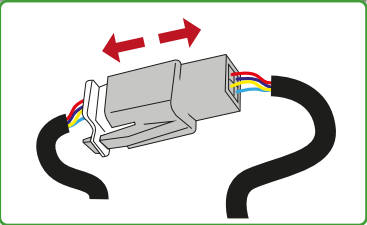
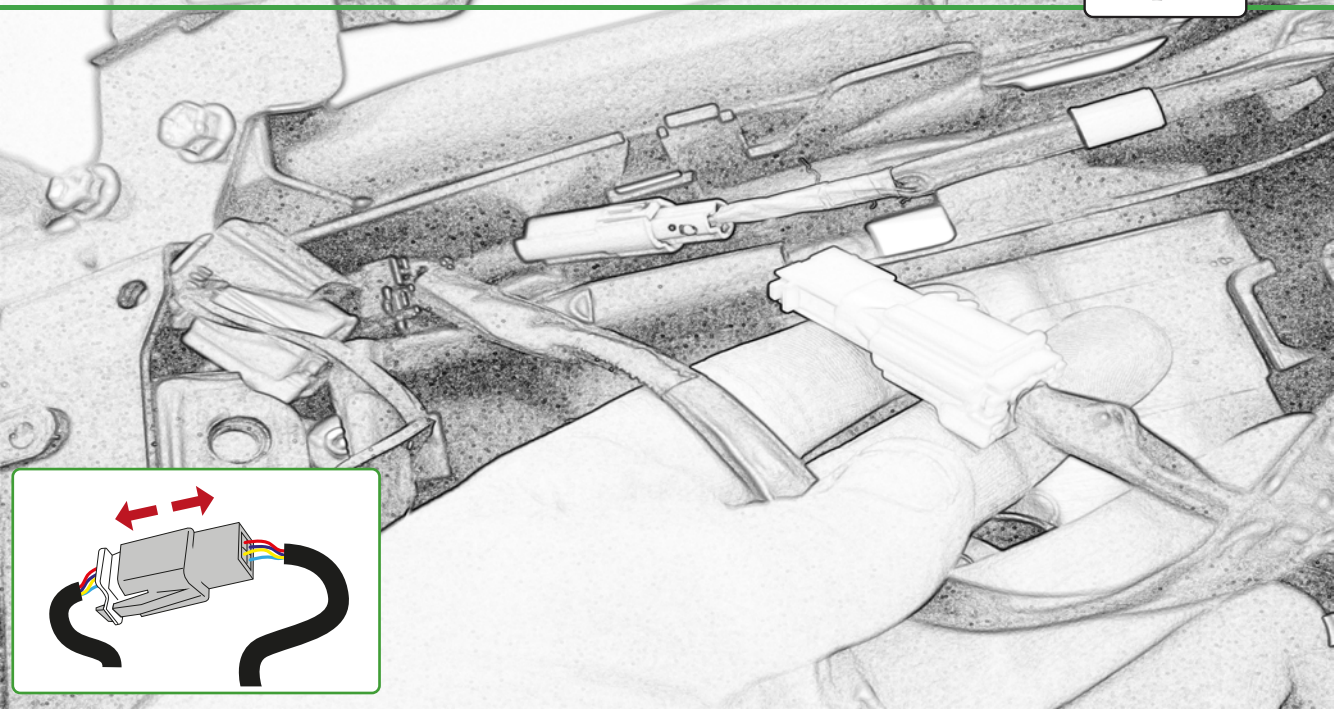

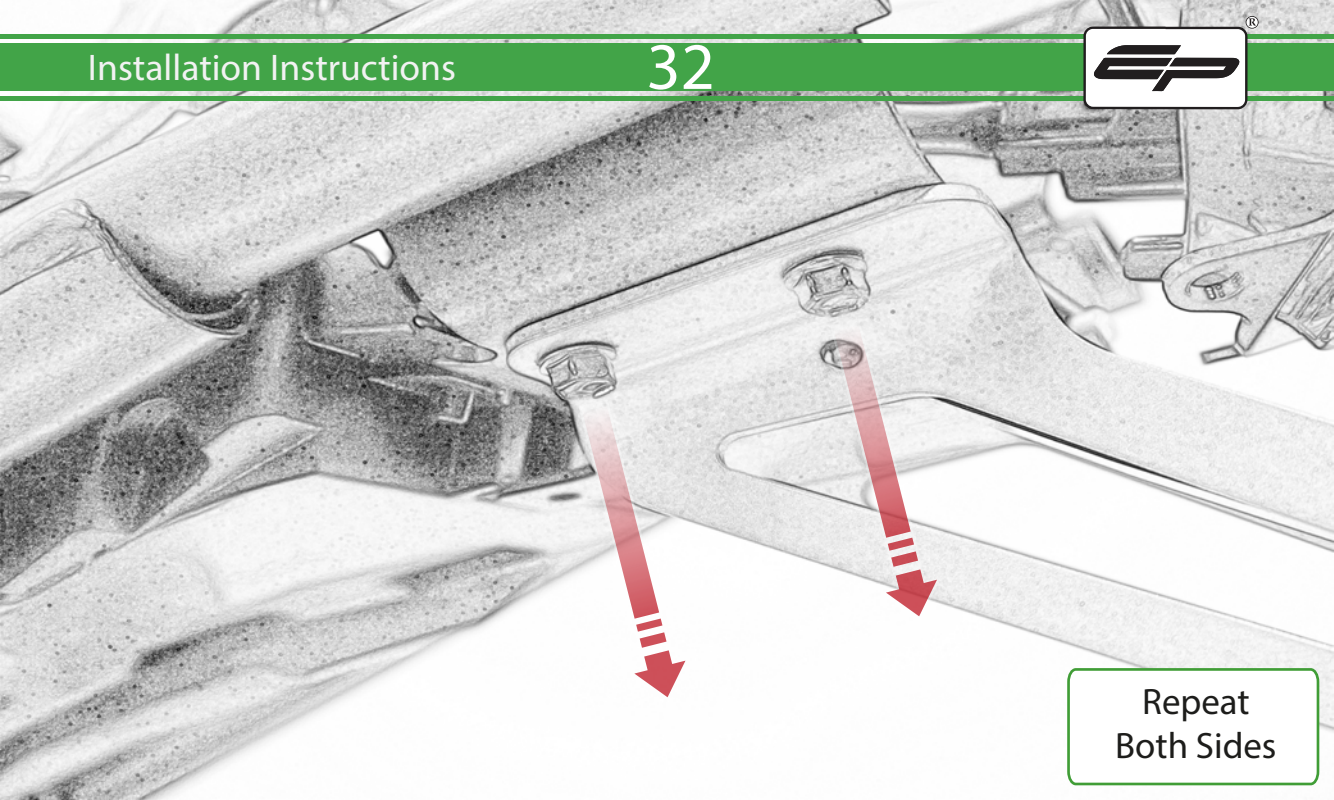

Repeat
Both Sides

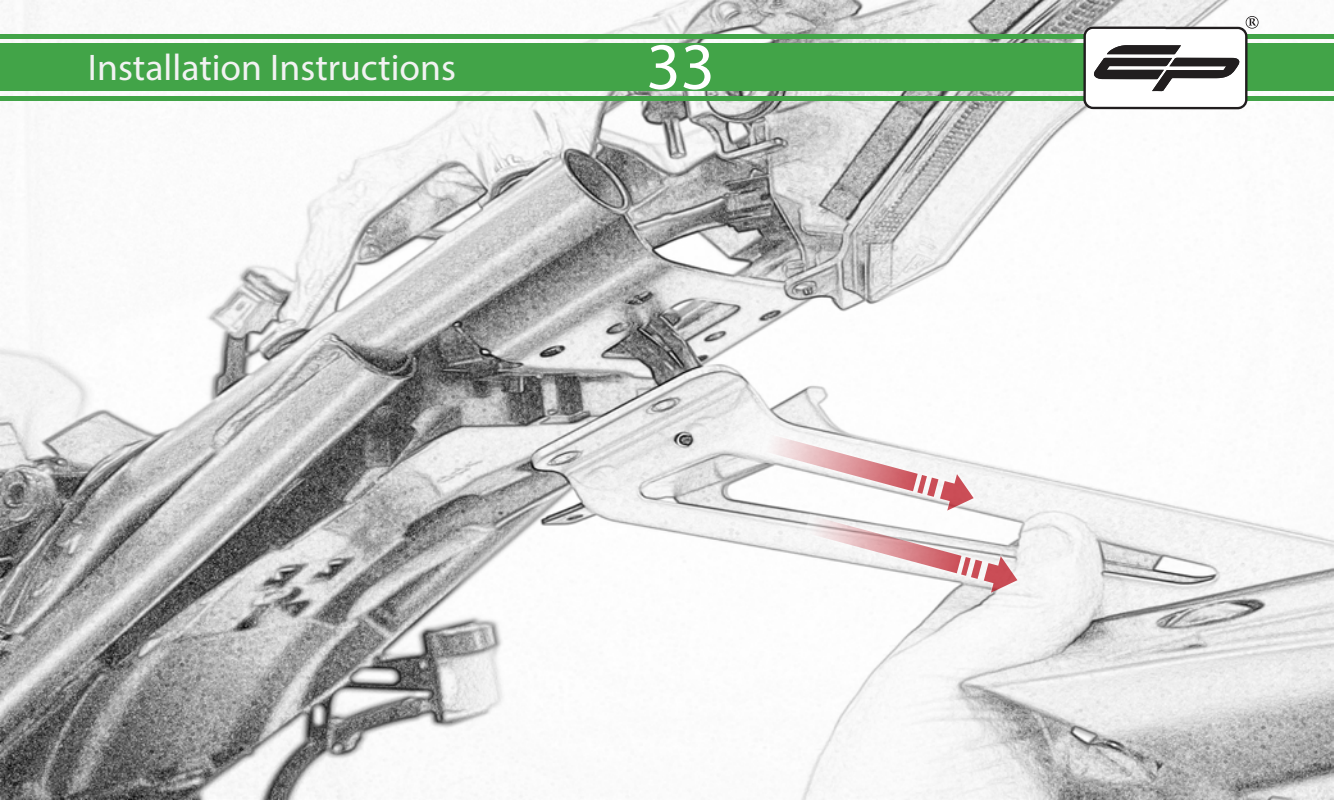

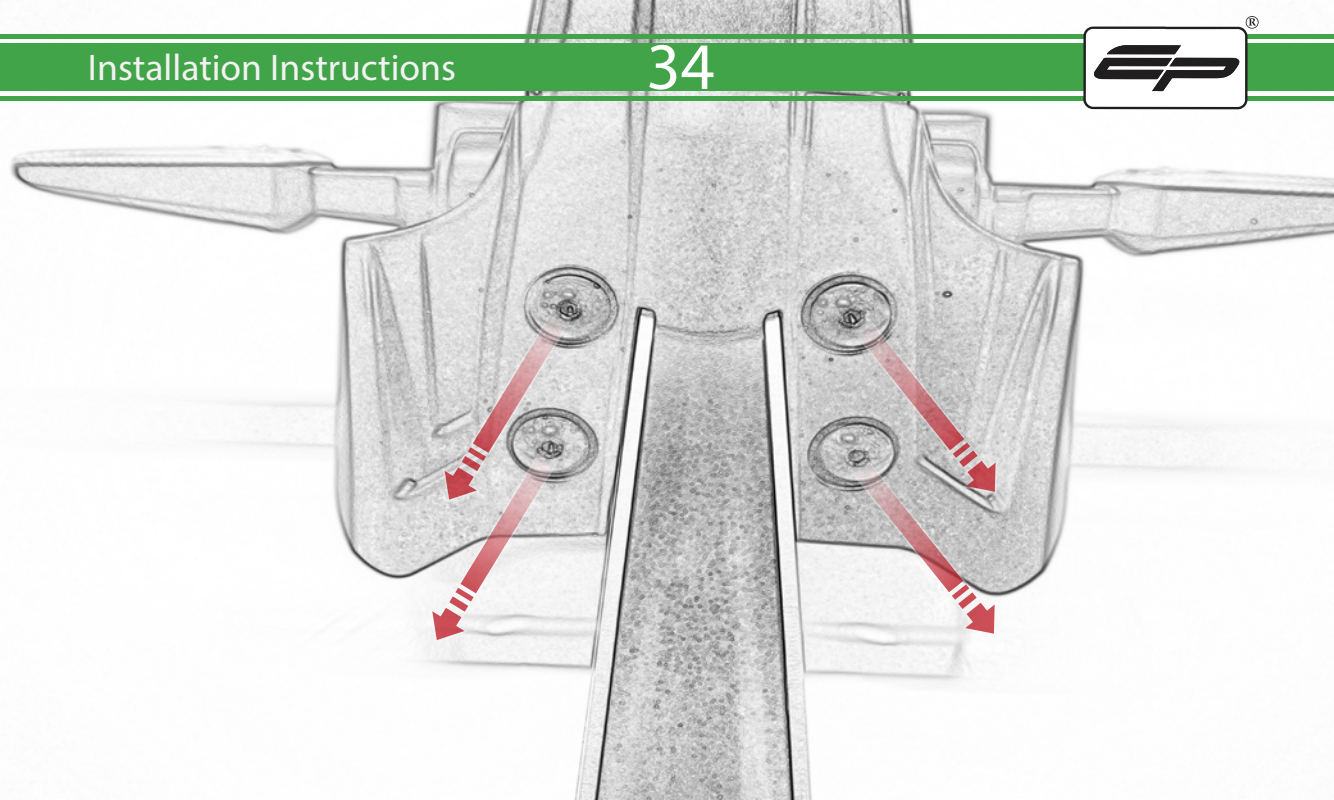

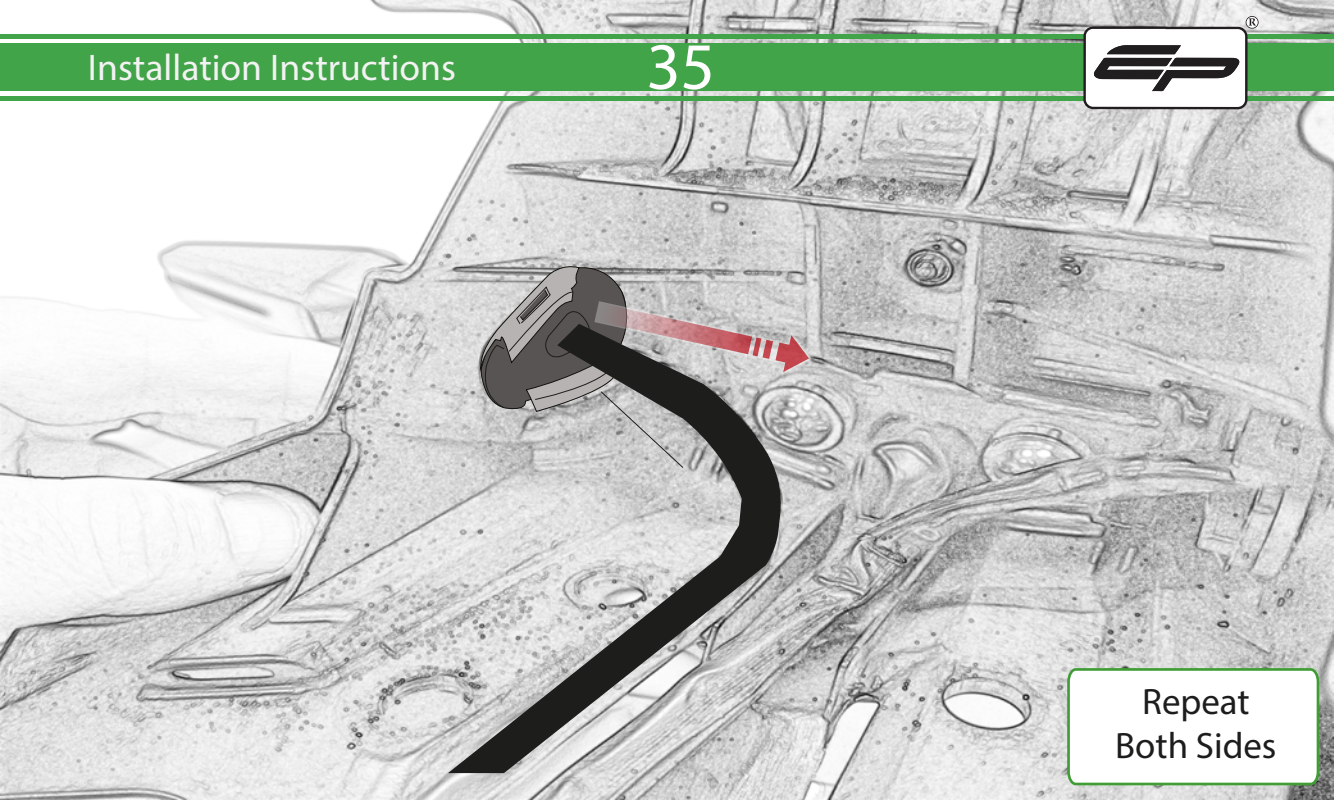

Repeat
Both Sides

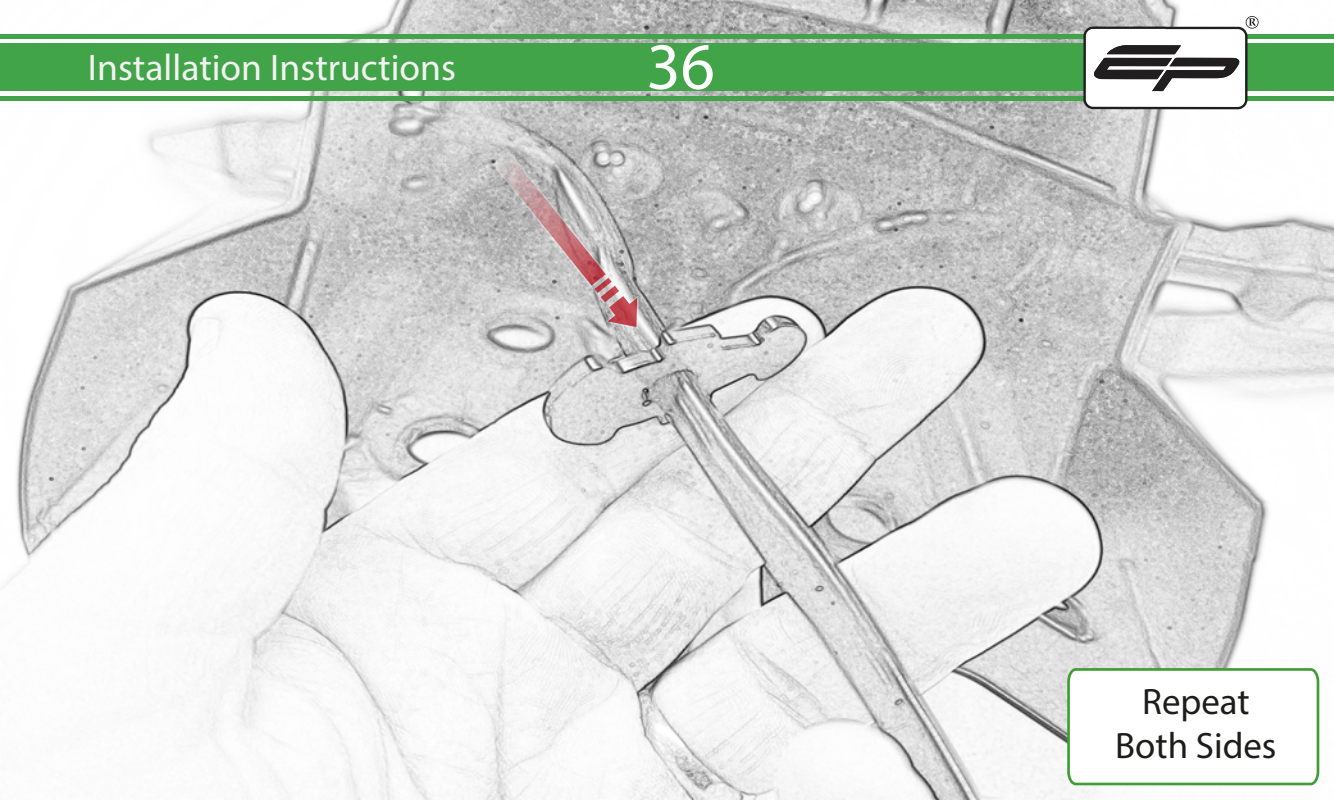

Repeat
Both Sides

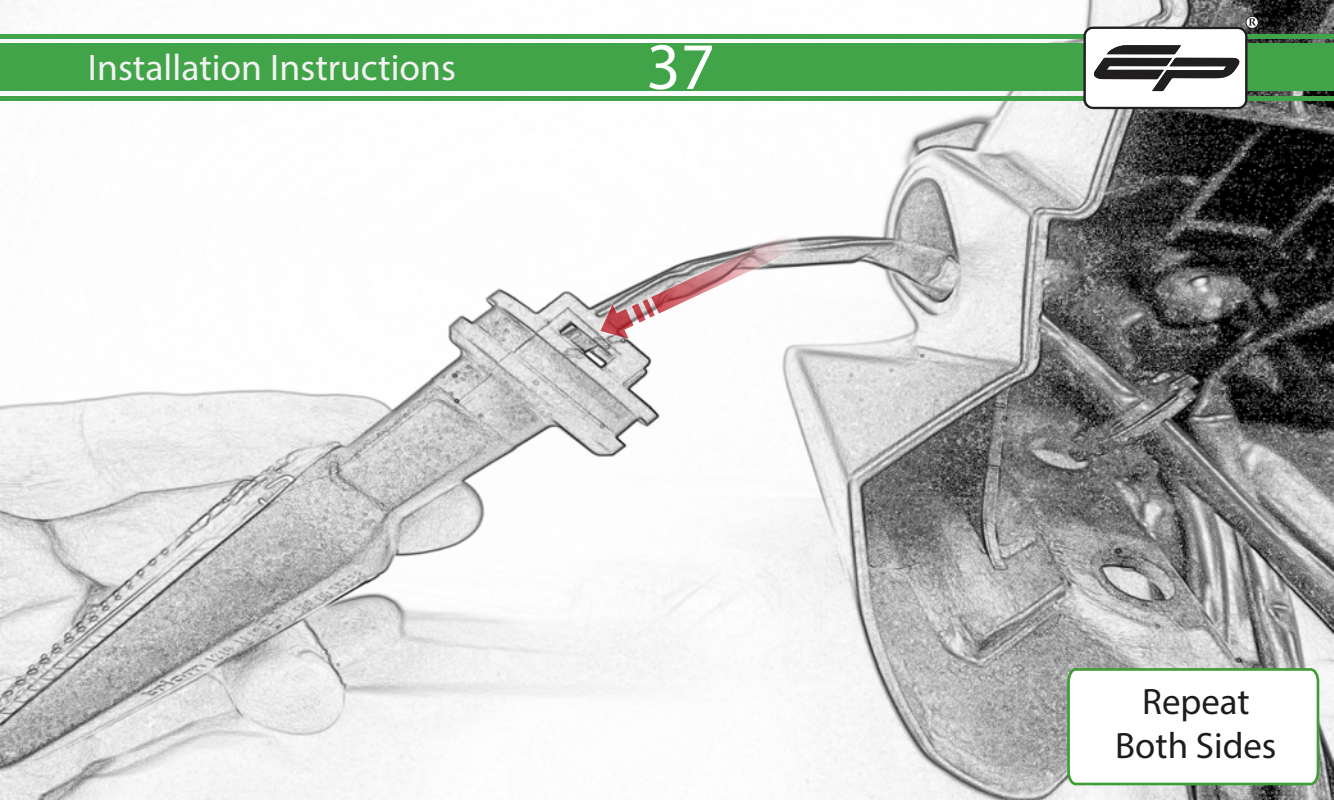

Repeat
Both Sides

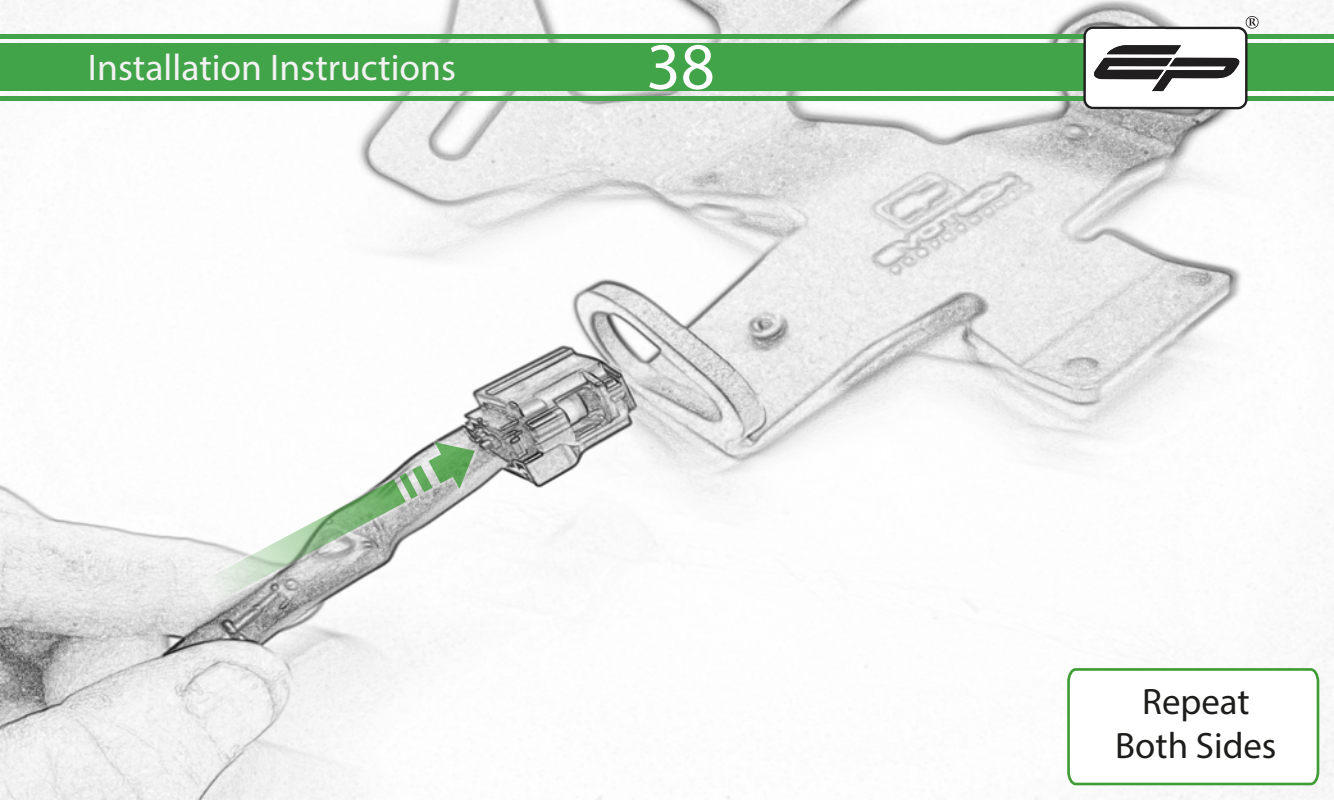

Repeat
Both Sides

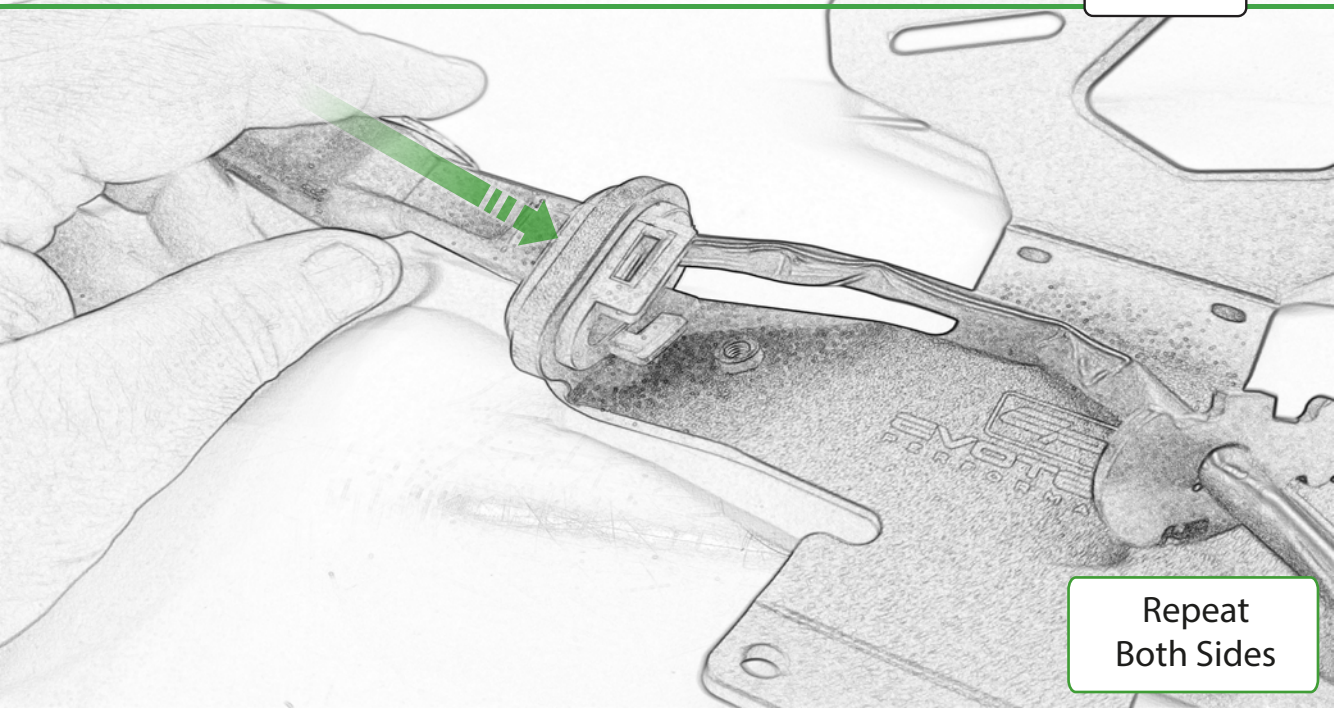

Repeat
Both Sides

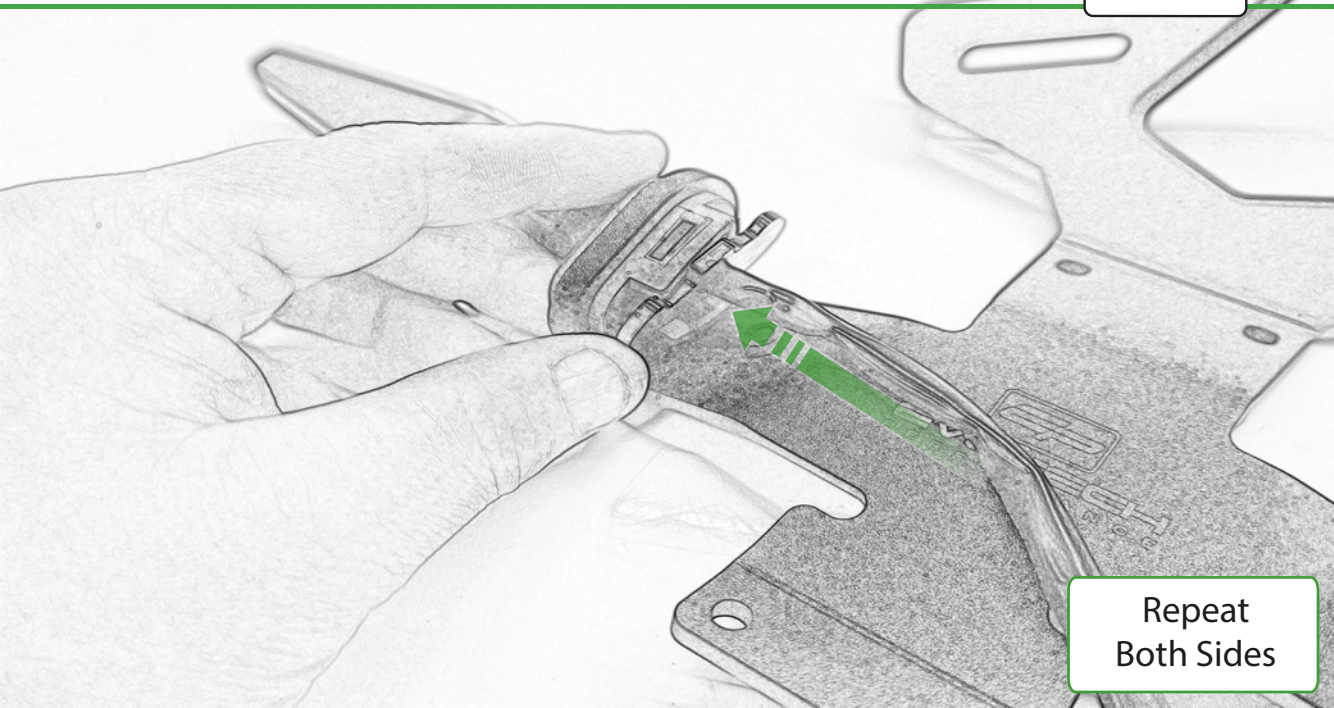

Repeat
Both Sides

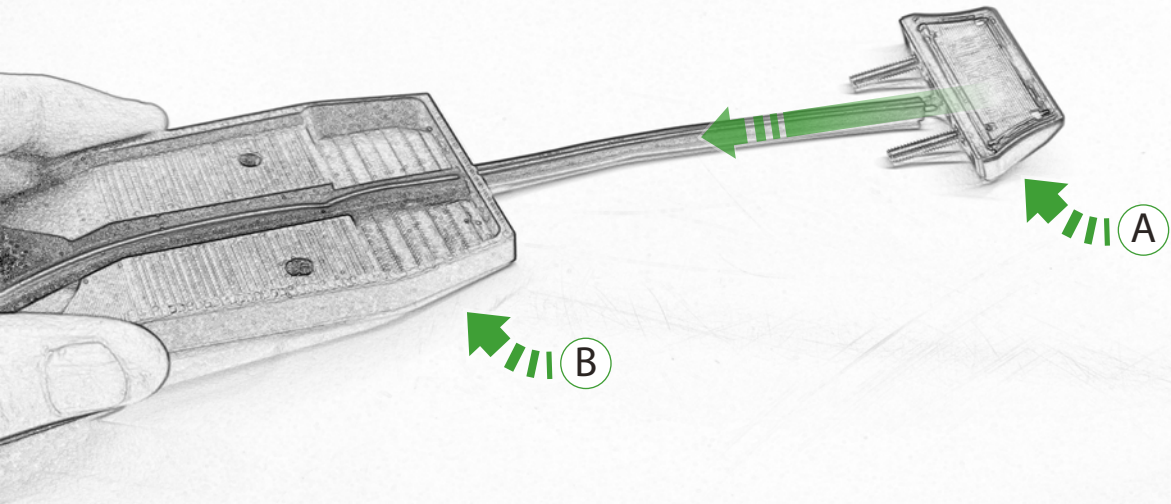

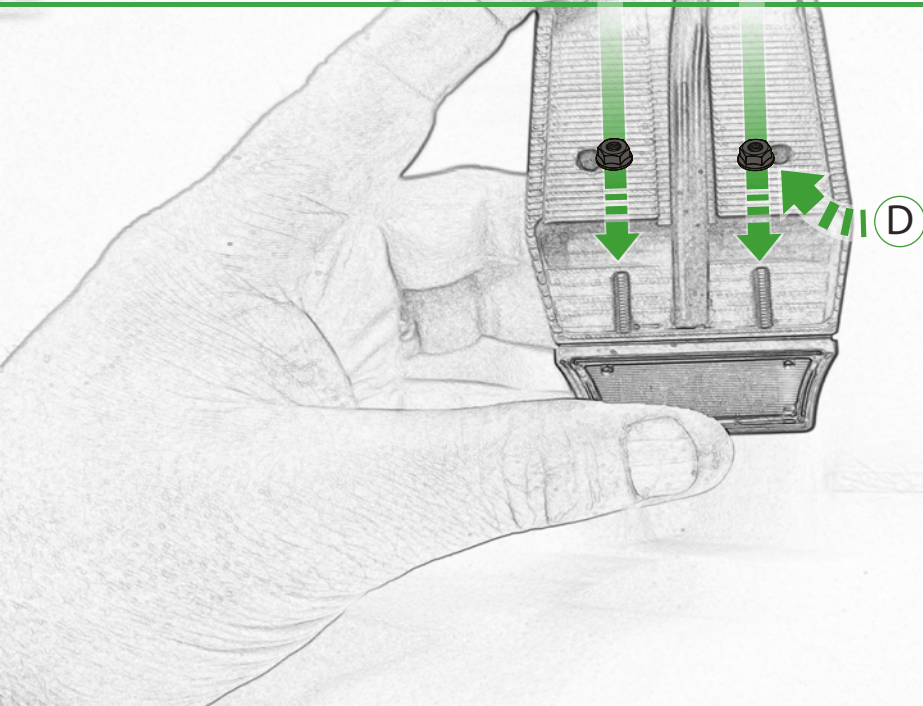

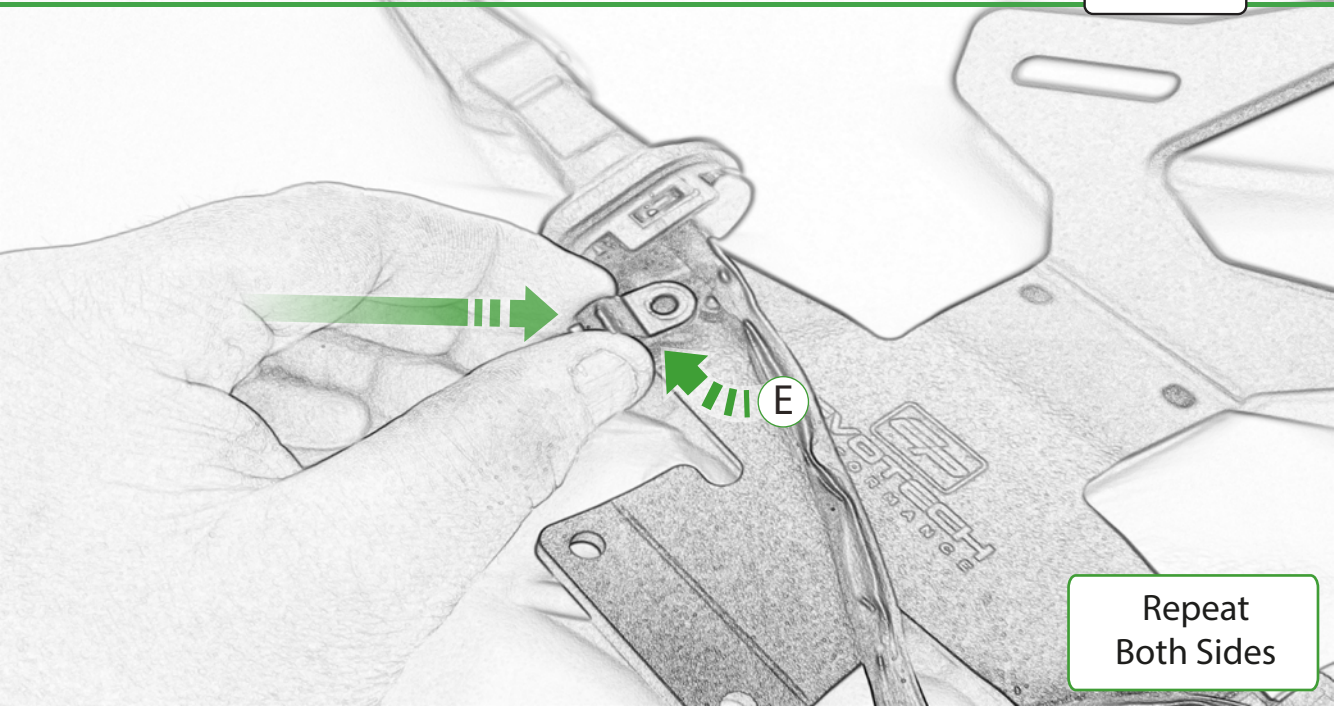

Repeat
Both Sides

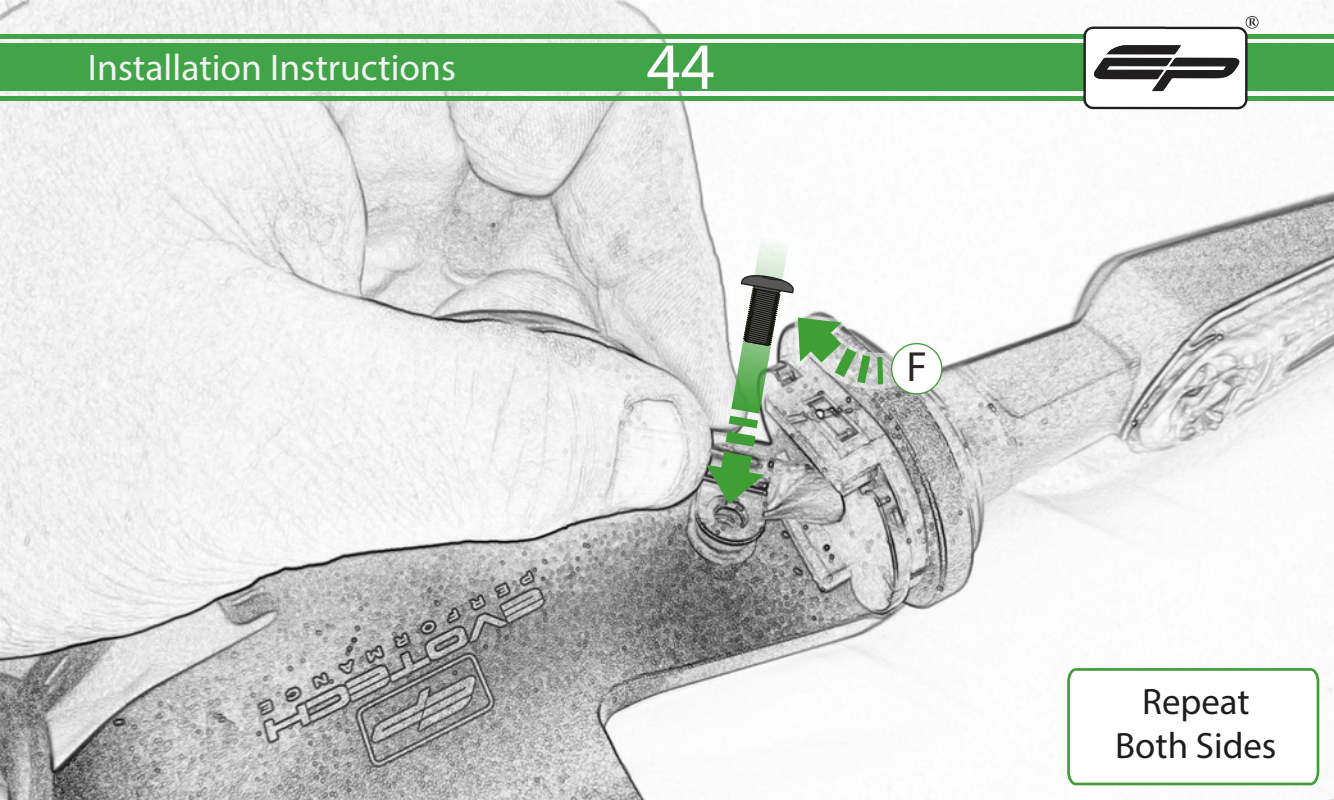

Repeat
Both Sides

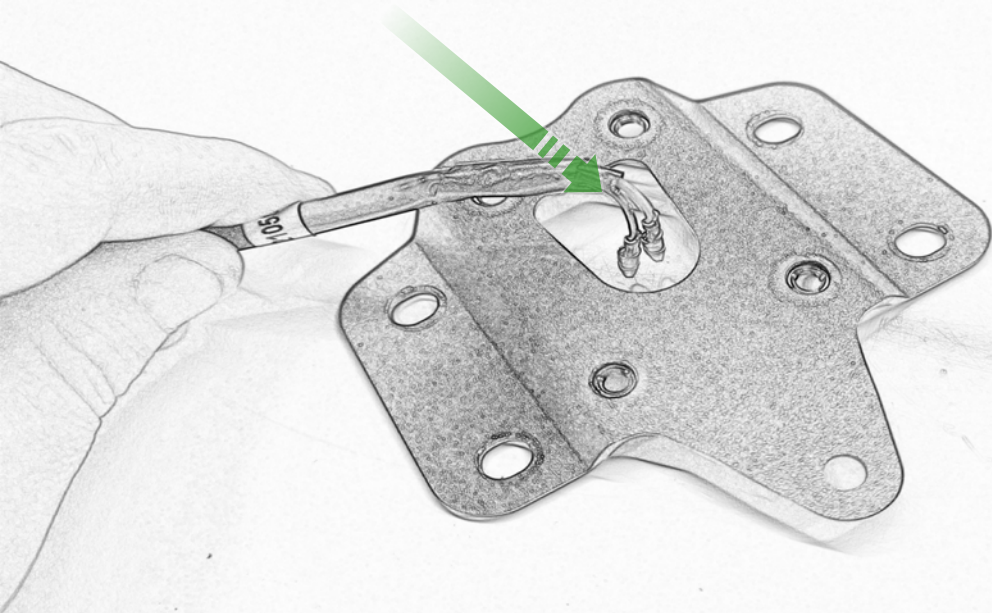

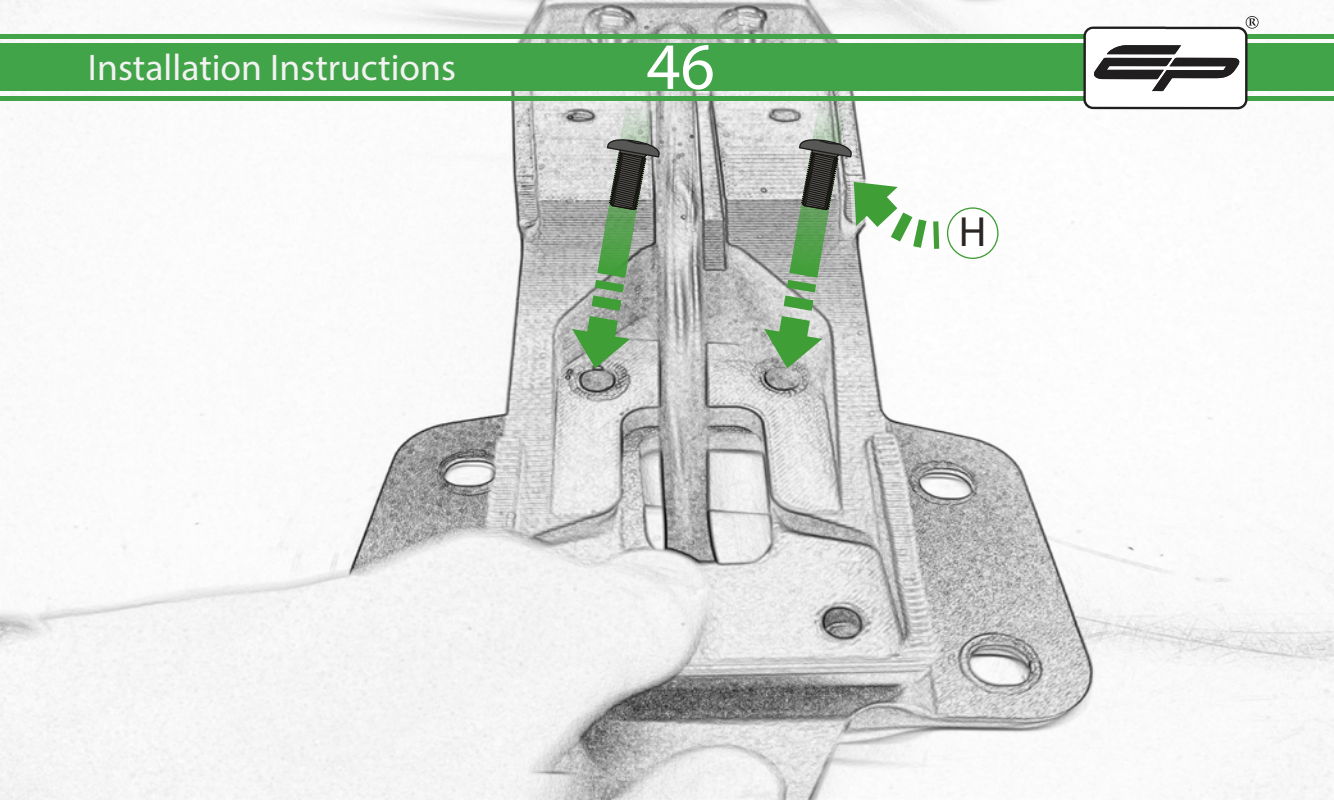

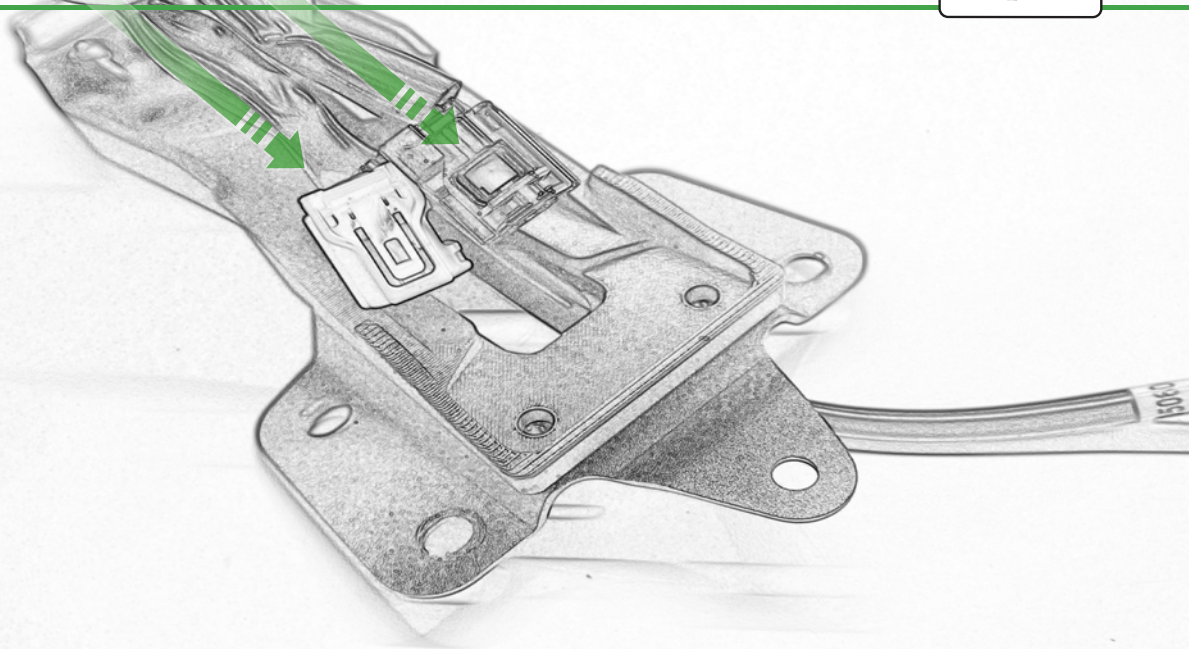

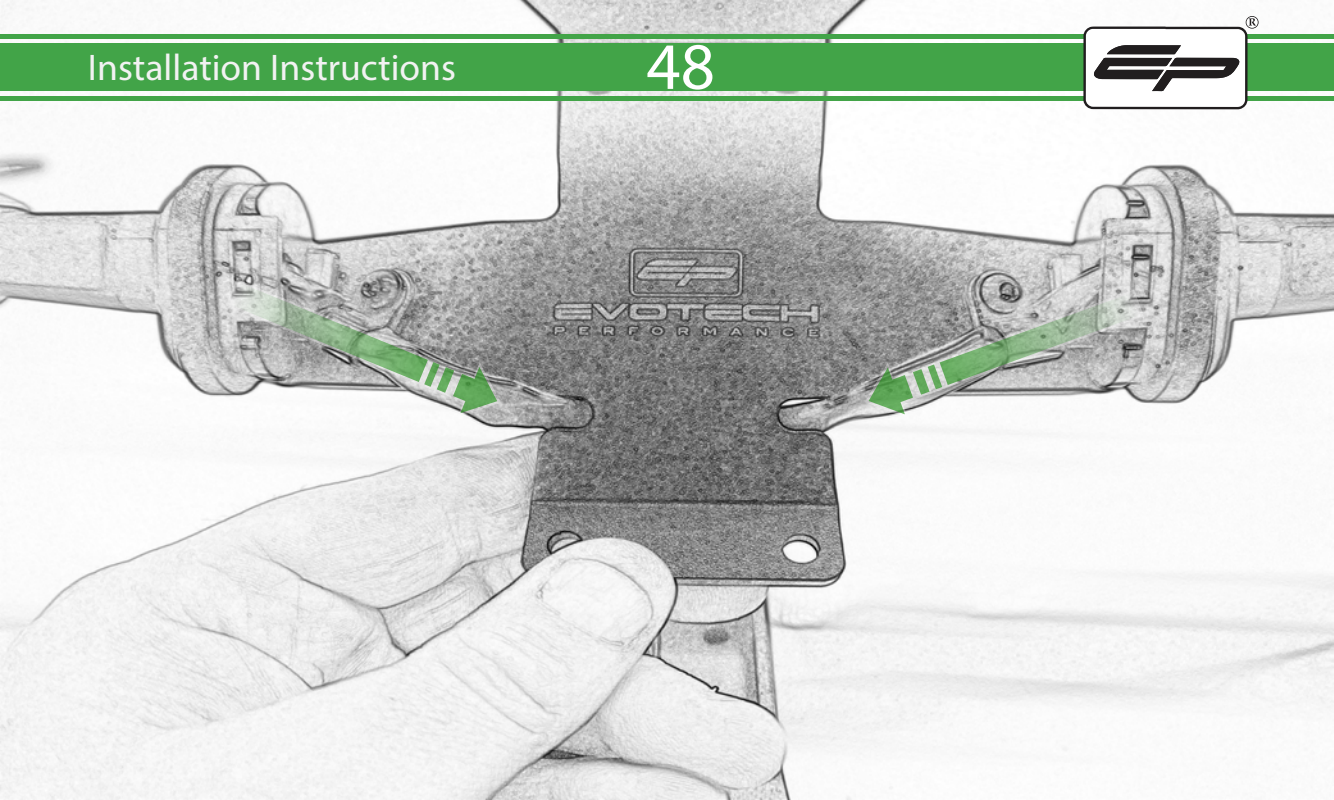

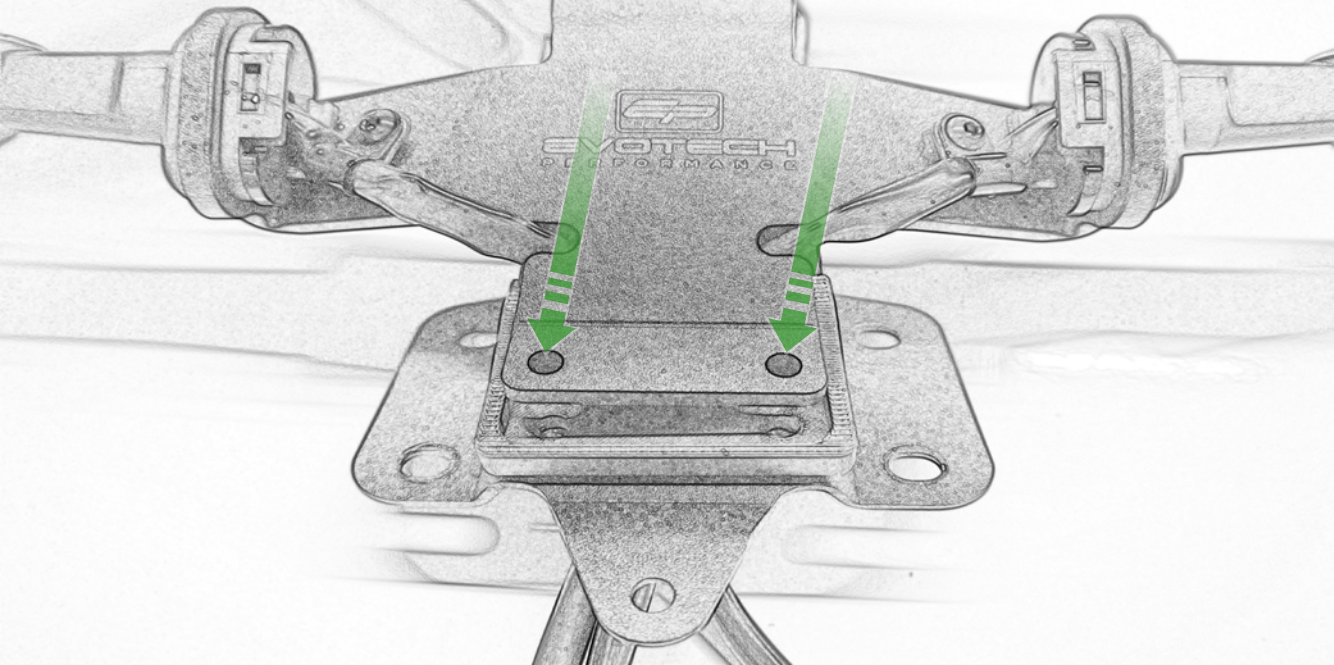

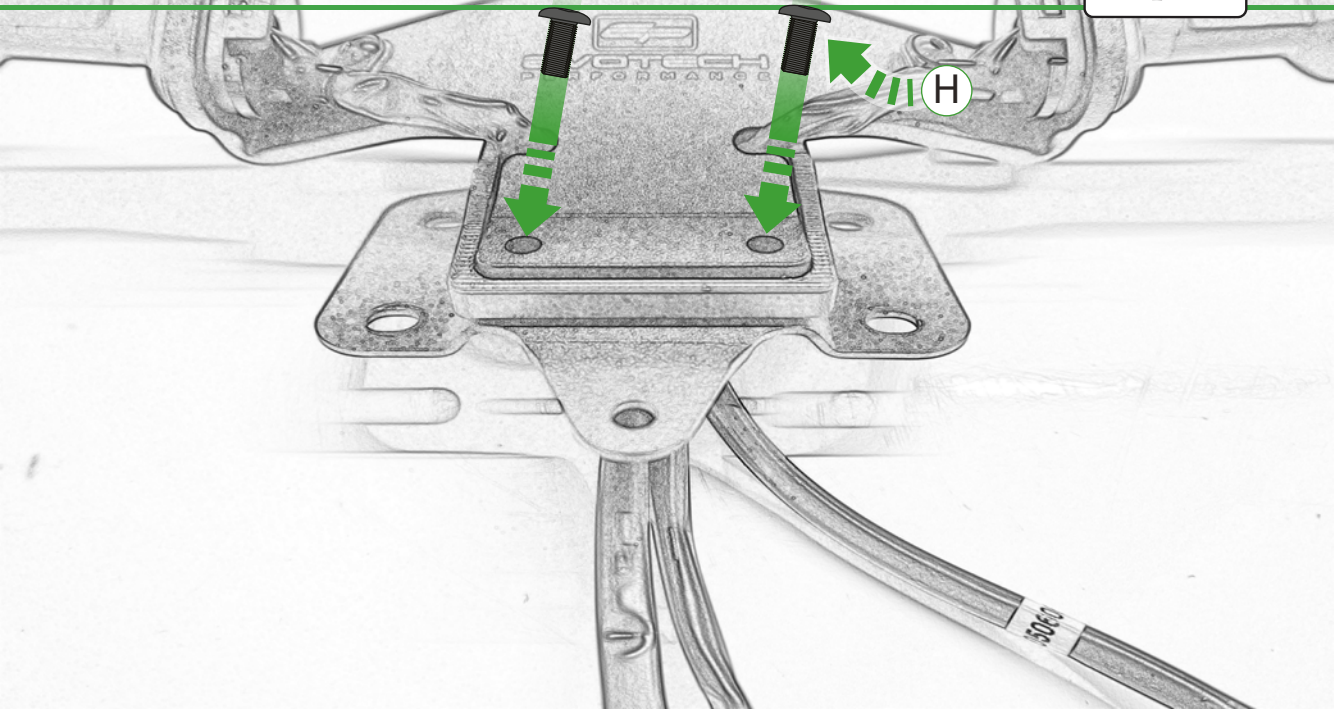

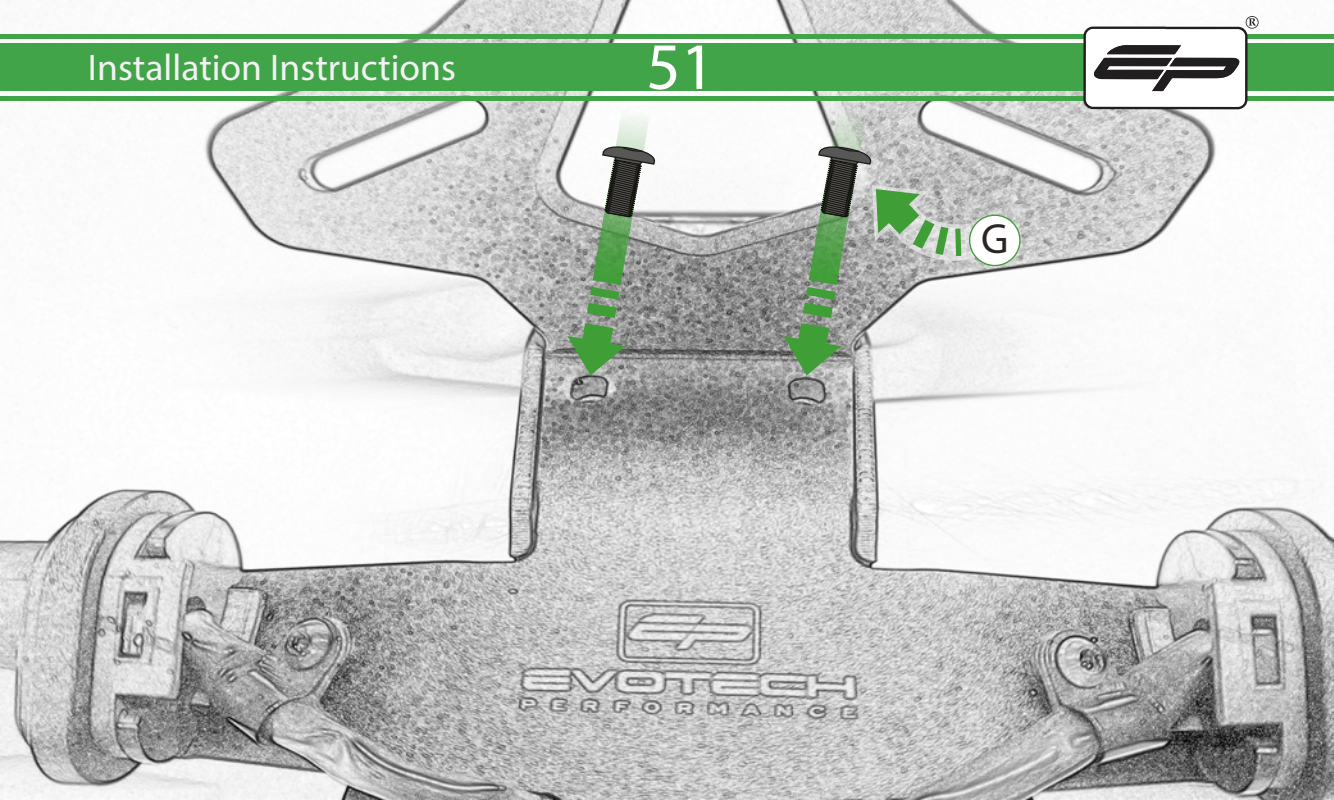

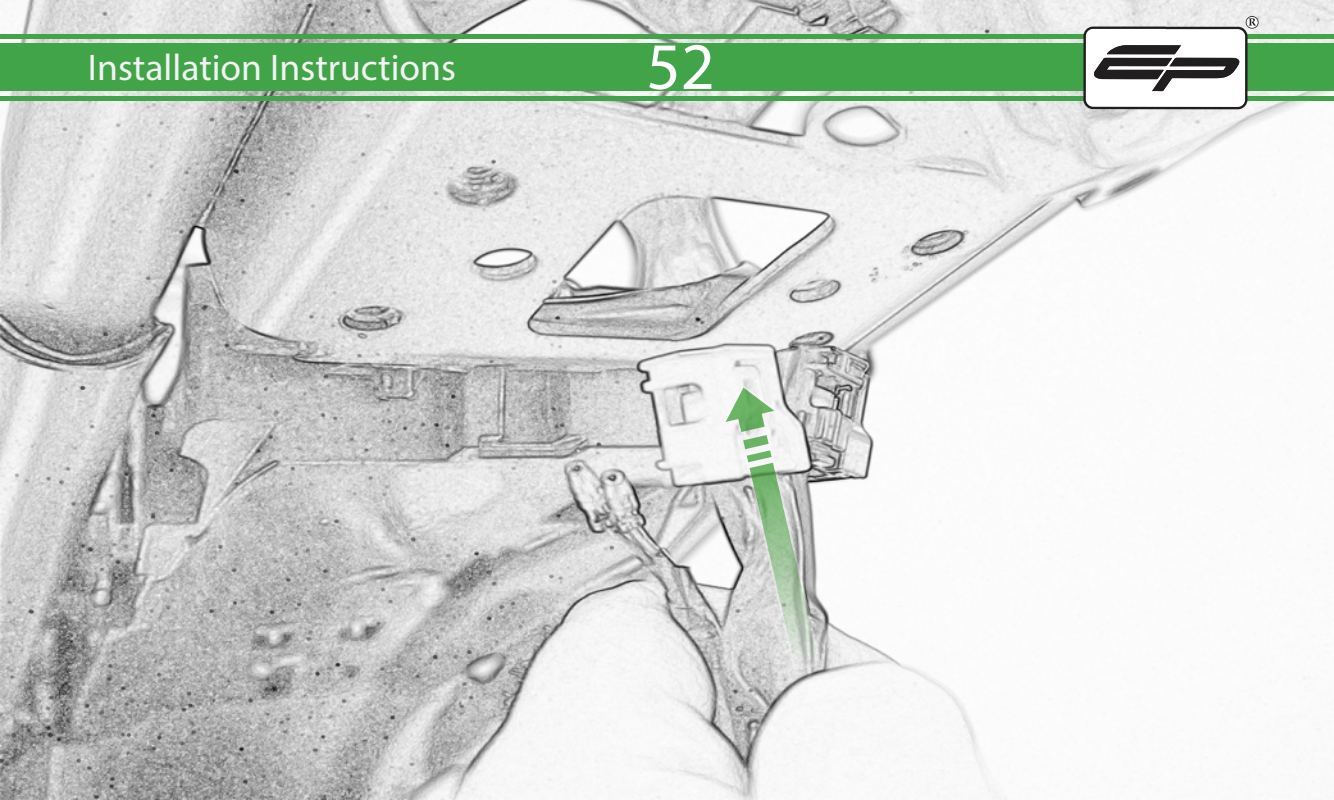

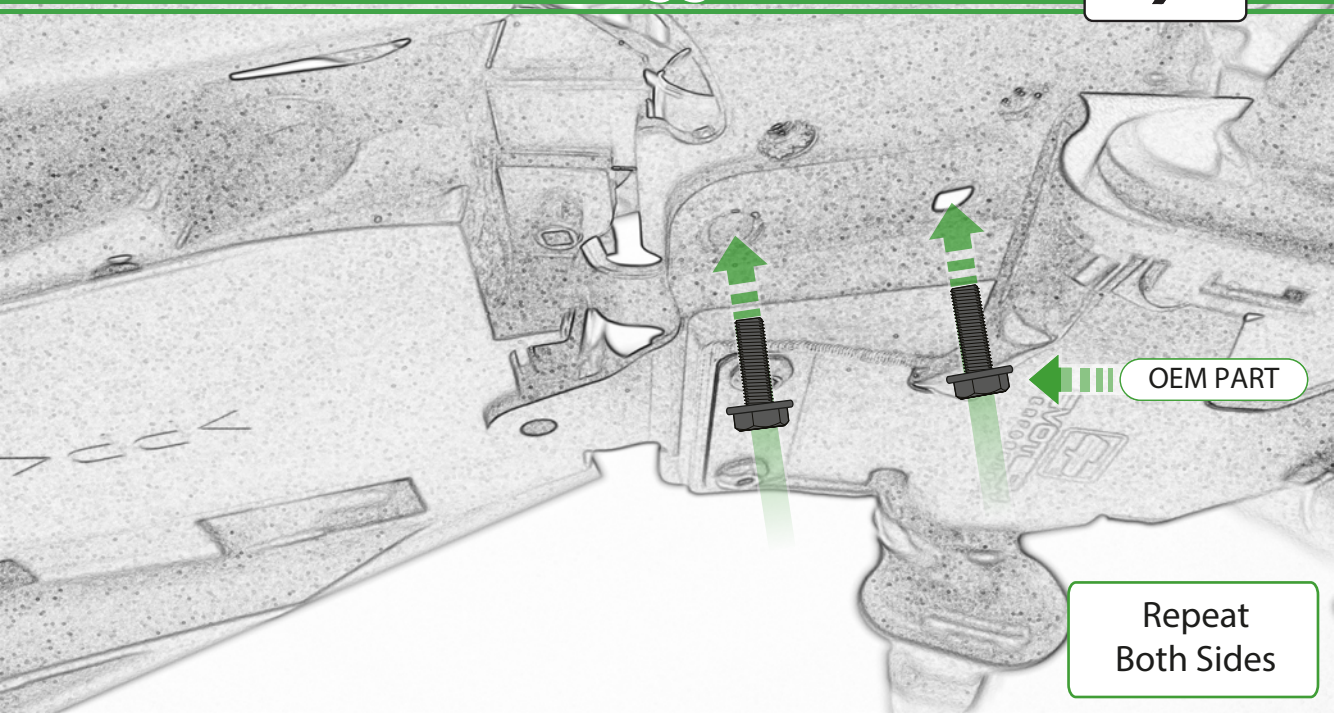

OEM PART

Repeat
Both Sides

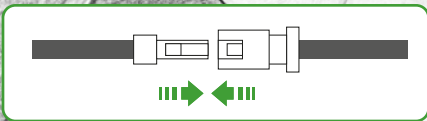
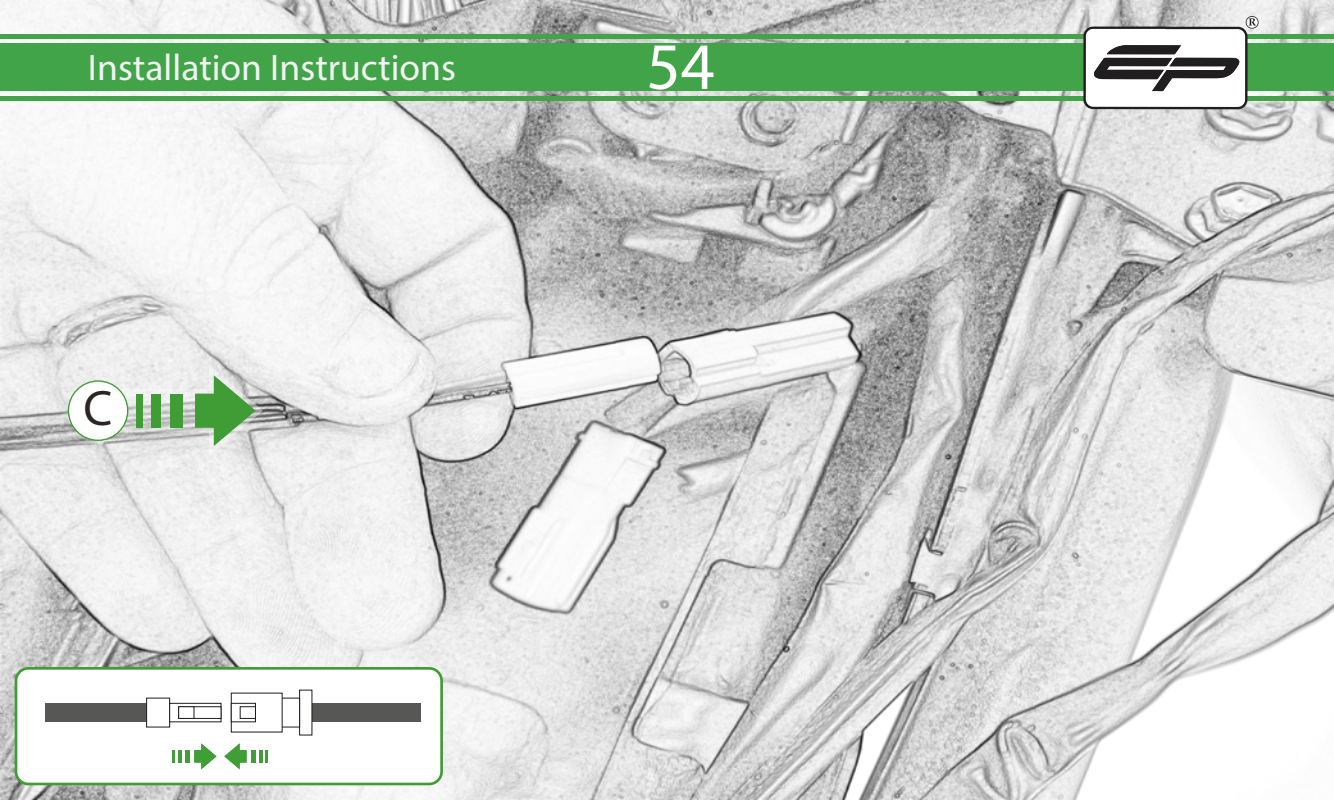

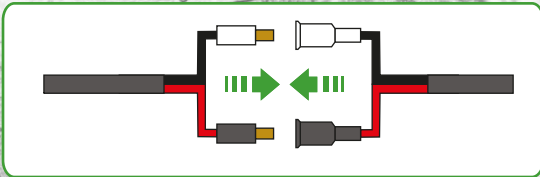
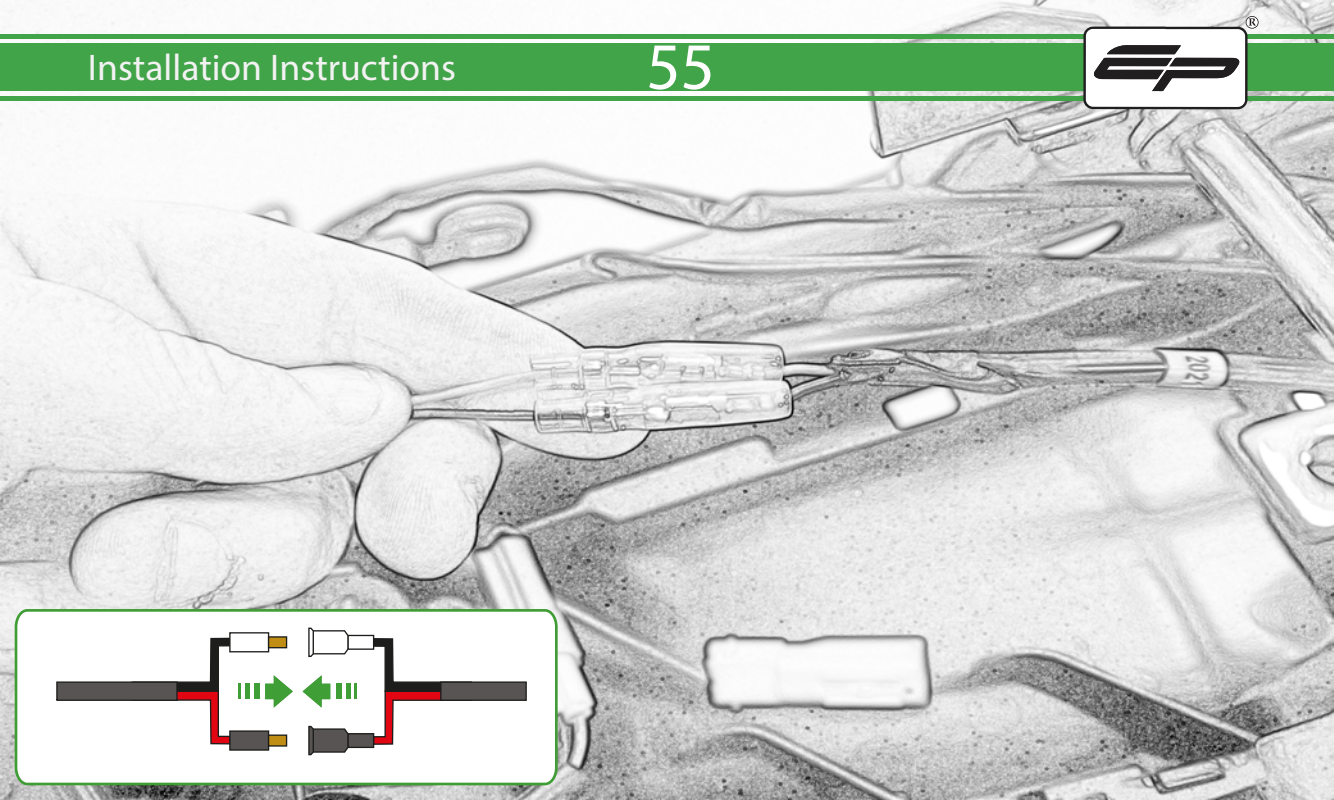

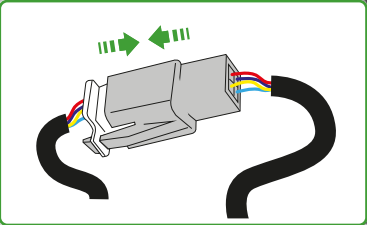
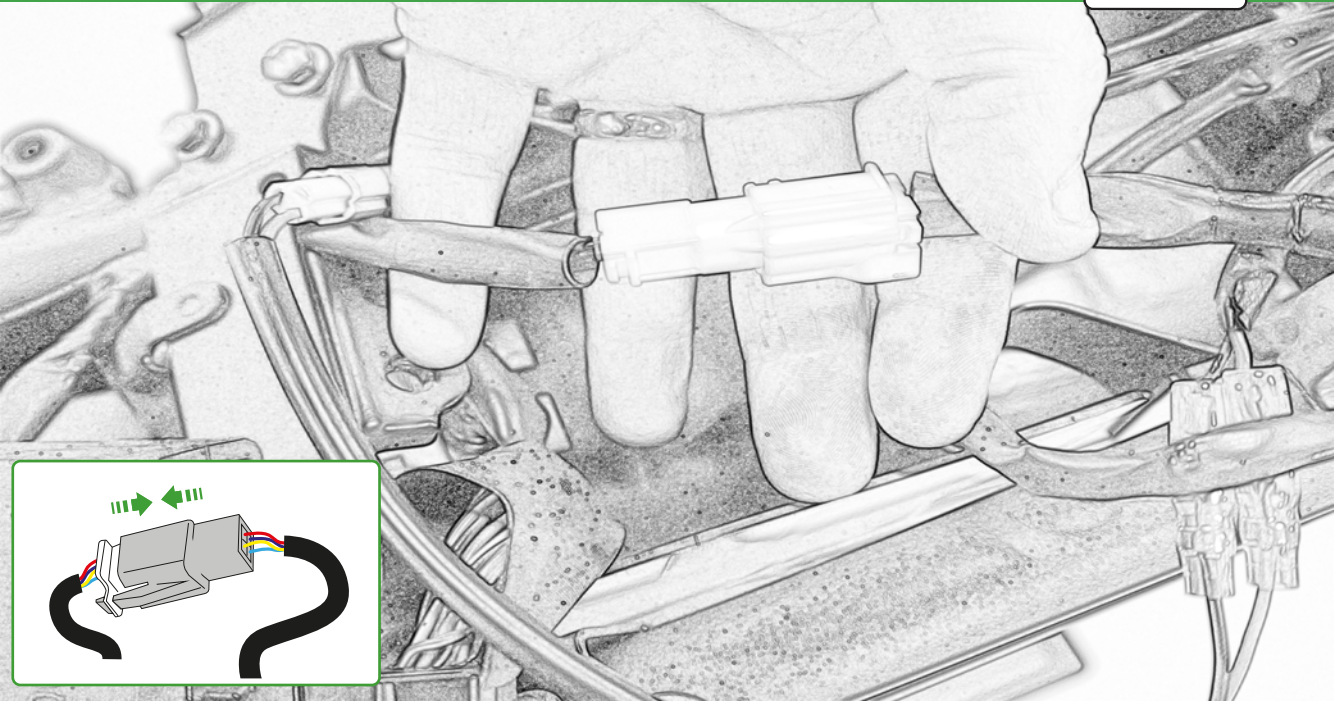

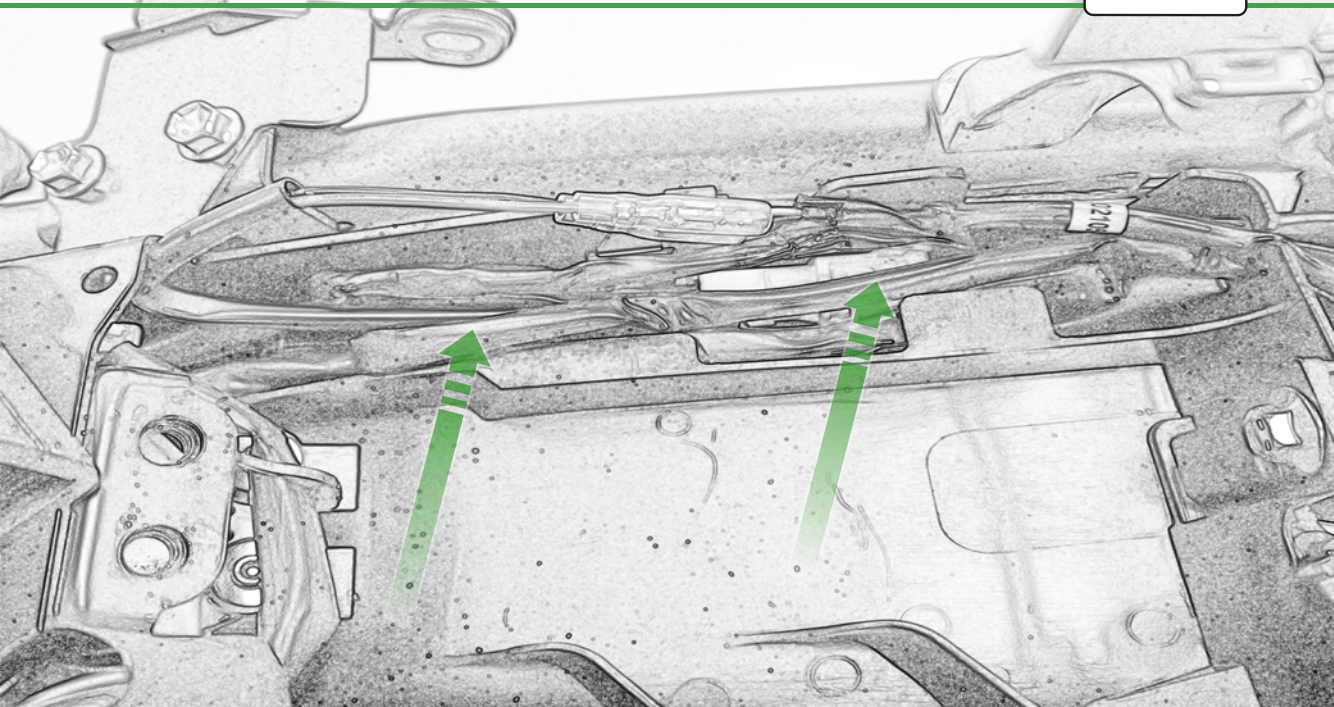

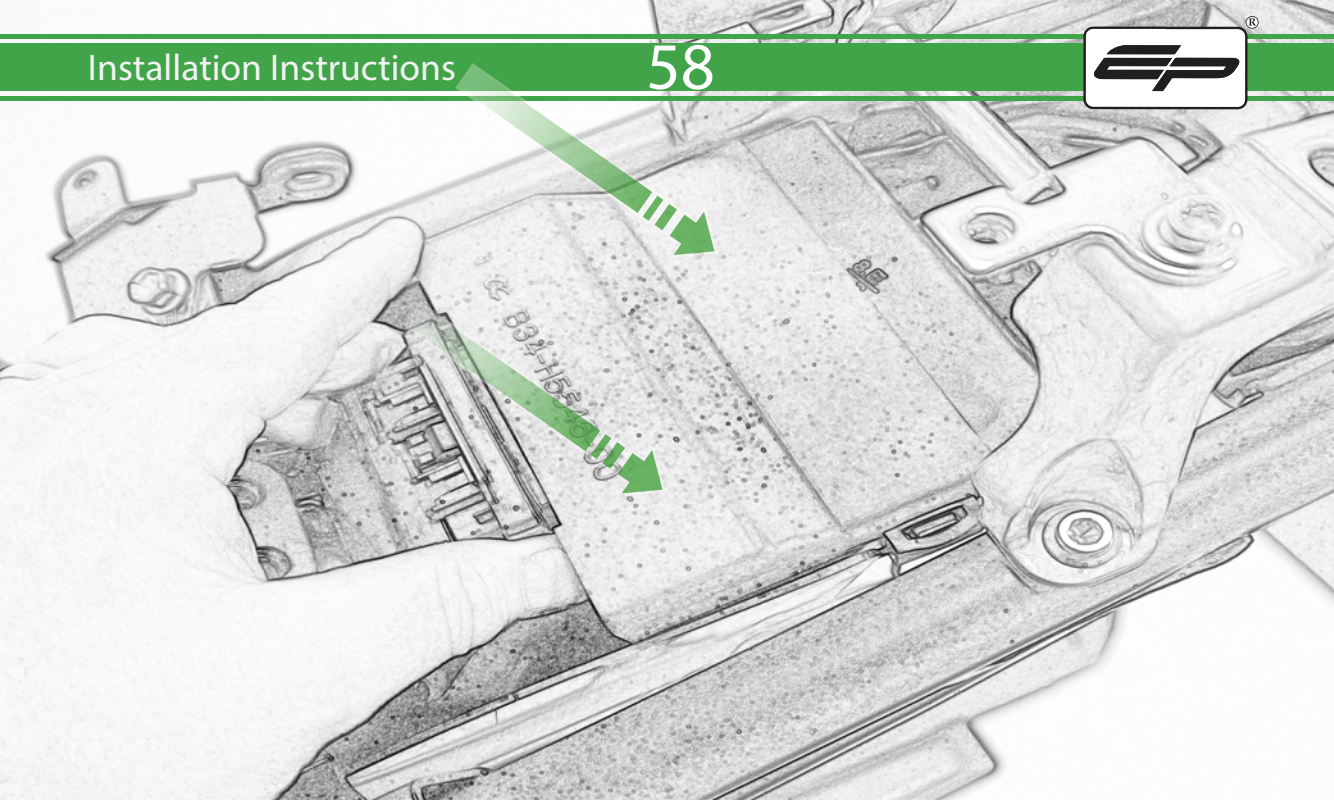

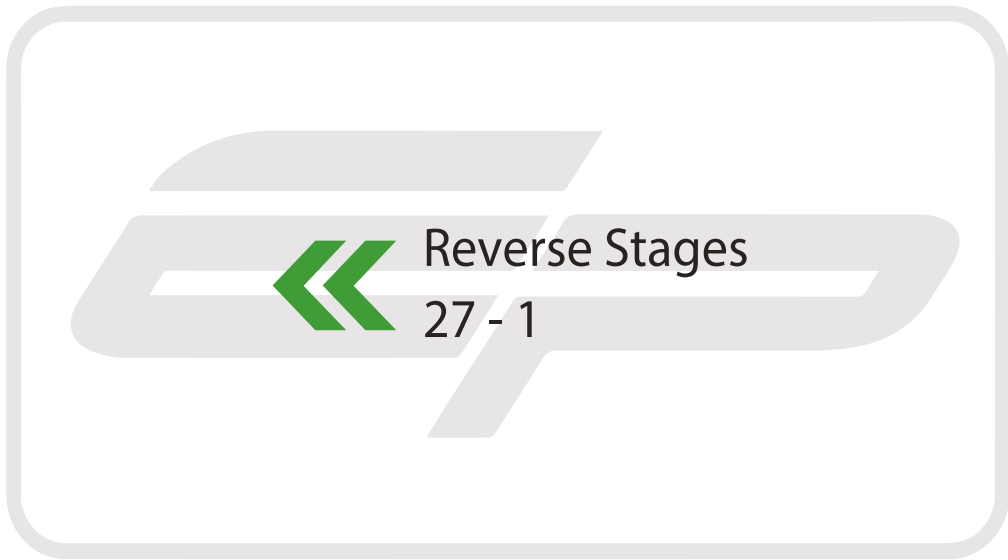

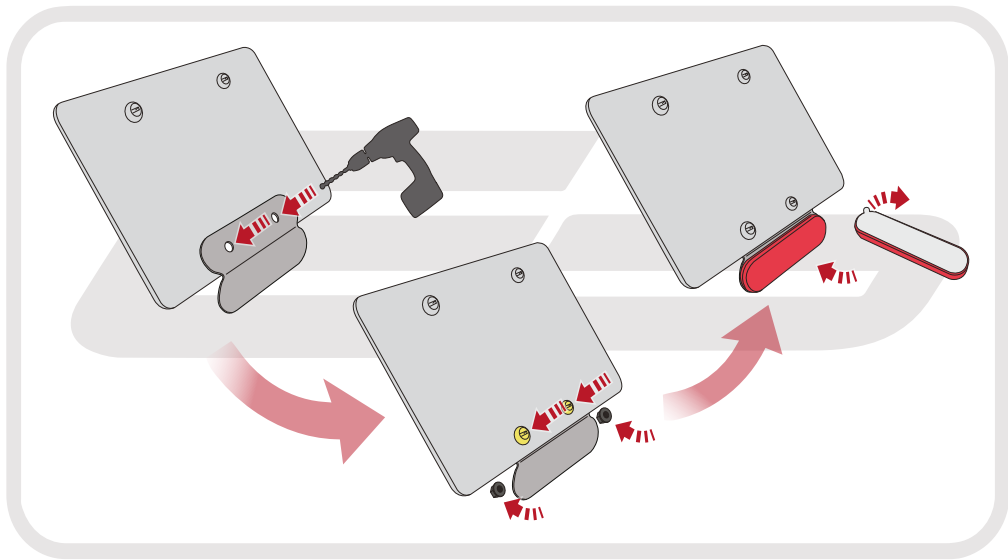

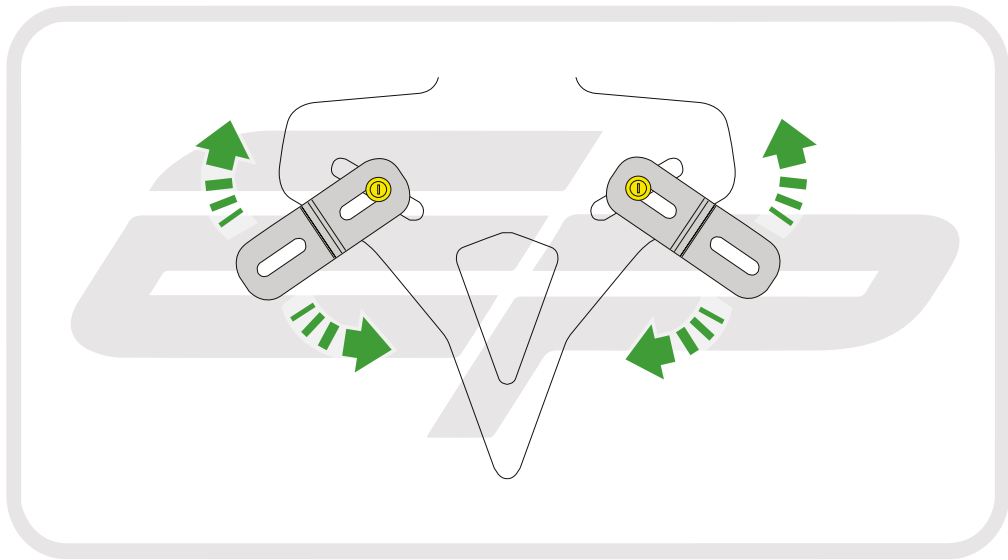



ESSENTIAL CHECKS



After installation of your tail tidy ensure that the licence plate does not contact the rear tyre when suspension is fully compressed.

Ensure all electrics including indicators, tail light, brake light and licence plate light lights are working correctly before riding the motorcycle.

It is recommended that periodic inspections are made to ensure that all fixings are fully tightend.



EVOTECH®
P E R F O R M A N C E

www.evotech-performance.com

